



nationalchimney.com

800.897.8481

2026

PRODUCT CATALOG



BUILDING A LEGACY

OF SUPERIOR PRODUCTS, SERVICE EXCELLENCE & SAFETY

TABLE OF CONTENTS

M-Flex Liners & Kits	9
Smoothwall Liner Kits	18
M-Flex Pre-Insulated	20
M-Flex Plus.....	24
Premier Flex Heavywall	26
Premier Flex Lite.....	28
M-Flex Aluminum Liner Kits.....	32
Co-Linear Kits & Caps	34
Premier Rigid	36
Chimney Components	39
Stainless Steel Components	40
Insulation	56
Imperial Stove Pipe.....	60
Selkirk Model DSP Stove Pipe	62
Selkirk Model Ultra-Temp Class A	65
Selkirk Model UPP Pellet Vent.....	68
Chimney Caps	74
Dampers.....	82
Hearth Accessories	94
Masonry Repair	102
Prior Fire	110
Brushes & Rods.....	112
Cleaning & Maintenance Tools	116
Inspection & Service Equipment	126
Safety & Protective Gear	128
Sales Tools	132
Custom Worksheets	136

Dear Valued Customers,

As we head into 2026, we want to thank you for your continued trust in National Chimney. Your partnership drives our mission to deliver superior products and service as the only veteran-owned leader in the chimney manufacturing industry for over three decades.

This year is already off to a strong start with the launch of our new Chimney Defender Meredith Next Gen product line at the NCSG Show—where it was honored with the 2026 Pete Luter Innovation Award for Best New Product. This recognition reflects our commitment to developing solutions that truly make a difference in the field, and we're just getting started. We have additional Chimney Defender Meredith Next Gen innovations in the pipeline that we're excited to bring to you soon.

We also continue to invest in our operations to better serve you. Our Indianapolis Corporate Headquarters has expanded by 25,000 sq ft to enhance manufacturing capabilities and support our new products, while our Maryland and Vermont facilities are optimized for even faster deliveries.

This catalog features new and exclusive products inspired by your feedback, along with a calendar of events where we hope to connect with you in person. Your voice remains critical to our progress, and we invite you to participate in a quick 5-minute survey at the end of this catalog. As a thank you, you'll receive \$50 off your next order.

Beyond manufacturing, National Chimney proudly supports industry organizations like NCSG, CSIA, HPBA, and regional guilds. We are also deeply committed to giving back through initiatives such as Sweep Away Cancer, which we are proud to help found, and Warrior Horse—both causes that are close to our hearts.

We look forward to a strong year ahead and continued success for chimney professionals everywhere. Thank you for being the foundation of our success. Your partnership inspires us to keep pushing forward, and we're honored to serve you.



Darin Bibeau, CEO

Evan Havers, President



OUR CORE VALUES:

- H** HONESTY & INTEGRITY
- O** OPERATING AT THE HIGHEST LEVEL AT ALL TIMES
- N** NEVER SAY NEVER
- O** ORIGINALITY, THINKING OUTSIDE THE BOX
- R** RESPECT THE CUSTOMER, THE COMPANY & YOURSELF

WHERE TO FIND US

We ensure fast, reliable service to our customers across all 50 states!

OUR LOCATIONS

Mid-Atlantic

2601 Emory Road
Finksburg, MD 21048

Corporate Headquarters

2147C Fletcher Avenue
Indianapolis, IN 46203

Northeast

3 Green Tree Drive
South Burlington, VT 05403

HOW TO STAY IN TOUCH

GIVE US A CALL
800.897.8481

FOLLOW US ON SOCIAL MEDIA



VISIT US ONLINE

NationalChimney.com



MEET OUR TEAM!

LEADERSHIP



DARIN BIBEAU
CEO



EVAN HAVERS
President



KRISTIN TROMBLEY
CFO

SALES TEAM



RON VAUGHN
National
Sales Manager



SCOTT TAYLOR
Midwest
Sales Specialist



DENNIS SICKMEN
Mid-Atlantic
Sales Specialist



THOMAS MEREDITH
Chimney Defender
Solutions Specialist

AMBASSADORS

RYAN HALL
GREGG BOSS
JON WHITE



WELCOME TO OUR E-STORE!



Order Online to Save Time & Money!

- ✓ Manage your orders with ease
- ✓ Pay invoices seamlessly
- ✓ View order history anytime
- ✓ Avoid order discrepancies
- ✓ And much more!

NationalChimneyStore.com 

WANT TO RECEIVE
\$50 OFF
YOUR E-STORE ORDER?



Take Our Customer Satisfaction Survey!

Complete the survey and receive a coupon delivered to your inbox! Your insights help us enhance our products, services, and overall shopping experience.

Learn more on page 133.



Your Guide to Using the e-Store

Getting Started

1. Visit NationalChimneyStore.com.
2. Click “Create a new user for your account.”
3. On the next screen, enter your account number and billing ZIP code. This information is available on any invoice or statement.
4. Once verified, you’ll be prompted to input your desired login details.
5. Click “Create Login”—and you’re in!

Account Support

Under “**My Account**” in the navigation panel, you can update: Address, Contact Info, Password, Saved Credit Cards, Shipping Addresses, and Shipping Accounts

For assistance, call 800-897-8481

Navigation Tips

1. If the left **navigation panel disappears**, click the three-bar menu icon in the top left corner to bring it back.
2. To **lock/unlock the navigation panel** in view, click the lock icon at the top right corner of the panel.
3. To **return to the homepage** at any time, click the National Chimney logo in the top left corner of the screen.

Ordering Products

There are multiple ways to access product listings.

From the Top of the Homepage:

Under the “Products and Ordering” section you can select: Shop, Price List, Recently Viewed Products, Favorites, Bulk Add to Cart (*best if you know your part numbers*)

From the Left Navigation Bar:

Click “Products” to expand a full drop-down menu, which includes all the options above and more.

Orders & Shipments

Go to “Orders & Shipments” in the left navigation panel or on the homepage. A drop-down menu will appear with the following options:

- All Orders
- Backorders
- Completed Orders
- Products Ordered (*Detail/Summary of Quantity*)
- Shipments

Accessing Your Cart

You can view your cart two ways:

1. Cart Icon – Click the shopping cart icon in the top right corner of any page. A menu with your cart contents will appear on the right side.
2. Navigation Bar – Click “Ordering” in the left navigation panel, then select “My Shopping Cart.”

View Your Invoices

In the left navigation panel, click “Invoices.” You’ll be able to view Open Invoices, Paid Invoices, and Products Invoiced. To make a payment click “Payments & Credits.”

Use the drop-down to:

- Pay an Invoice
- View Past Payments
- View / Apply Credits



INTRODUCING... CHIMNEYTM DEFENDER

Meredith Next Gen Built

National Backed



TO LEARN MORE, VISIT:

chimneydefender.com



Next Gen
Crown Repair

Waterproof Protection for Chimney Crowns

Next Gen Crown Repair creates a seamless waterproof shield that keeps water out for good, stopping leaks and restoring crowns that last a lifetime. Engineered for crown repair & resurfacing, new crown construction, exterior chimney corbels, and more.

1 gal: **\$81.98** 2 gal: **\$155.32**



Next Gen
Flashing Repair

Permanent Protection for Chimney Flashings

Next Gen Flashing Repair seals and protects vulnerable areas with a permanent, hybrid moisture-cure formula that bonds to metal, brick, stone, and roofing materials—creating a watertight barrier.

1 gal: **\$79.86**



Next Gen
Water Repellent

Long-term Waterproof Protection for Chimneys

Next Gen Water Repellent penetrates deep into masonry chimneys, walls, and concrete surfaces to stop water intrusion while allowing trapped moisture vapor to escape naturally. Provides long-lasting protection with a breathable, invisible barrier.

5 gal: **\$208.49**



Glazed
Creosote
Remover

A Safer Way to Remove Dangerous Creosote

Glazed Creosote Remover is engineered to chemically soften, absorb, and release glazed creosote—drying up to 50% faster than traditional systems, dramatically decreasing the risk of chimney fires and hidden flue damage.

25 lb: **\$195.68**



M-FLEX

LINERS & KITS

MANUFACTURED BY
NATIONAL CHIMNEY



M-Flex Overview







	PRODUCTS	FEATURES	FUEL TYPES	APPLICATIONS
	M-Flex CB	Great standard liner that gets the job done	ALL	Any application
	M-Flex Plus	Most flexible & easy to work with	ALL	Any application
	Premier Flex Lite "PRL"	Lighter weight & easiest to work with	ALL	Any application
	Smoothwall "SW"	20% less drag than corrugated liners	ALL	When less drag is desired
	Premier Flex "NCPR"	Most durable liner	ALL	Most popular for stoves & fireplaces
	AL29-4CA	Best corrosion-fighting capabilities	GAS - 84% or higher efficiency	Furnaces, boilers
	Aluminum "DB"	Least expensive for gas installations	GAS - 83% or lower efficiency	Furnaces, boilers
	Rigid	20% less drag than corrugated liners	ALL	When less drag is desired

Manufactured by National Chimney • **M-FLEX LINERS & KITS**

MATERIALS	SHAPE OPTIONS	AVAILABLE IN KITS	SHIPPING OPTIONS	WARRANTY	UL LISTING
.006" (CB) Stainless Steel	Round, Oval, Rectangle	YES	FedEx Ground or freight truck	Lifetime, transferable residential warranty / 25-year commercial warranty (5-year for coal)	UL1777, 441, ULC-S635
.005" (CB) Stainless Steel	Round, Oval, Rectangle	YES	FedEx Ground or freight truck	Lifetime, transferable residential warranty / 25-year commercial warranty (5-year for coal)	UL1777, 441, ULC-S635
316 (All Fuel) or 304 (Wood & Pellet) .010" Stainless Steel	Round, Oval, Rectangle	YES	Must ship common carrier	Lifetime, transferable residential warranty / 25-year commercial warranty (5-year for coal)	UL1777, ULC-S635
316 2-ply .005" Stainless Steel (heavier than M-Flex, lighter than Premier Flex)	Round	YES	FedEx Ground or freight truck	Lifetime, transferable residential warranty / 25-year commercial warranty (5-year for coal)	UL1777, ULC-S635
316 (All Fuel) and 304 (Wood & Pellet) Stainless Steel	Round, Oval, Rectangle	YES	Must ship common carrier	Lifetime, transferable residential warranty / 25-year commercial warranty (5-year for coal)	UL1777, ULC-S635
AL29-4C .006"	Round, Oval	NO	FedEx Ground or freight truck	Lifetime, transferable residential warranty / 25-year commercial warranty	UL1777, ULC-S635
2-ply 3003 aluminum	Round	YES	FedEx Ground or freight truck	25-year commercial warranty	UL1777, ULC-S635
316 (All Fuel) and 304 (Wood & Pellet) Stainless Steel	Round, Oval, Rectangle	NO	FedEx Ground or freight truck	Lifetime, transferable residential warranty / 25-year commercial warranty (5-year for coal)	UL1777, ULC-S635

M-Flex Kits Overview

	KITS	PRODUCTS	FEATURES
	Standard Kit	<ul style="list-style-type: none"> • 2-Part Tee • Tee Cap • Top Kit 	Most popular, For all fuel types
	Basic Kit	<ul style="list-style-type: none"> • Top Kit • Stove Adapter 	Specialized for fireplace inserts
	Pellet / Corn Kit	<ul style="list-style-type: none"> • Pellet Tee • Tee Cap • Top Kit 	Similar to Standard Kit, for pellet/corn
	Aluminum Kit	<ul style="list-style-type: none"> • Mortar Collar • Aluminum Top Plate • Aluminum Cap 	For low efficiency gas (83% or lower)

M-Flex

Standard Liner Kit

M-FLEX standard liner kits are used for wood, oil, coal, and gas appliances. Our .006" (CB) standard kits comes with installation instructions and a lifetime warranty. This lining kit has been installed in venting applications since 1992 and continues to be the most popular "all fuels" kit we offer. We stock 3"- 8" inside diameter (ID) as well as 6"- 8" outside diameter (OD) in our .006" (CB). OD kits are the same price as ID kits, just add OD to the part number when ordering. (For example: CB625KITOD) Every job is unique, therefore if you need a larger plate size top kit add \$5 to the cost of the kit and specify when ordering. All standard tees have a snout length of 10". Extended snouts are also available. Call for details.



KIT INCLUDES:

- A** **Stainless steel liner**
UL 1777 Listed and Tested all fuel 316 .006" (CB)
- B** **Top kit** which includes a rain cap, and a 13"x13" top plate
- C** **Two-part tee** with removable 10" length take off (snout) 316
- D** **Tee end cap** 316

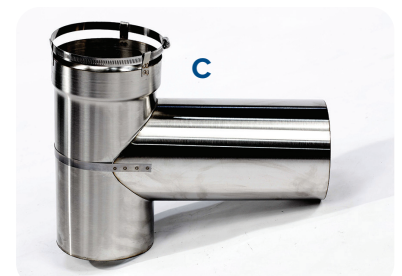
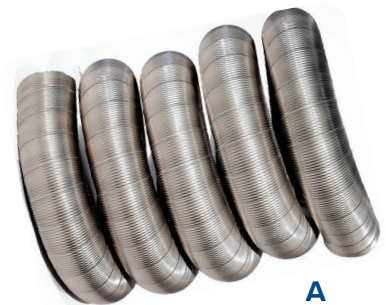

LINER OPTIONS	MATERIALS	WARRANTY	UL LISTING
<ul style="list-style-type: none"> .006" 316 (CB) Smoothwall (SW) 	316 .006" Stainless Steel	Lifetime warranty	UL1777
<ul style="list-style-type: none"> .006" 316 (CB) Smoothwall (SW) 	316 .006" Stainless Steel	Lifetime warranty	UL1777
<ul style="list-style-type: none"> .006" 316 (CB) 	316 .006" Stainless Steel	Lifetime warranty	UL1777
<ul style="list-style-type: none"> 3003 2-ply Aluminum liner (CB) 	Aluminum	25-year warranty	UL441

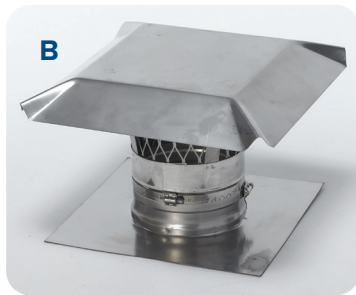

	3"	4"	5"	5.5"	6"	7"	8"
15'	CB315KIT \$328.20	CB415KIT \$331.77	CB515KIT \$365.60	CB5.515KIT \$396.42	CB615KIT \$417.17	CB715KIT \$488.76	CB815KIT \$527.05
20'	CB320KIT \$367.14	CB420KIT \$369.05	CB520KIT \$399.48	CB5.520KIT \$439.41	CB620KIT \$460.36	CB720KIT \$534.52	CB820KIT \$599.21
25'	CB325KIT \$410.90	CB425KIT \$432.99	CB525KIT \$463.07	CB5.525KIT \$500.28	CB625KIT \$532.25	CB725KIT \$606.81	CB825KIT \$684.81
30'	CB330KIT \$452.76	CB430KIT \$454.63	CB530KIT \$505.33	CB5.530KIT \$584.13	CB630KIT \$596.03	CB730KIT \$679.12	CB830KIT \$768.51
35'	CB335KIT \$494.59	CB435KIT \$496.49	CB535KIT \$547.60	CB5.535KIT \$620.14	CB635KIT \$680.18	CB735KIT \$751.37	CB835KIT \$852.20
40'	CB340KIT \$536.44	CB440KIT \$538.33	CB540KIT \$593.49	CB5.540KIT \$690.52	CB640KIT \$726.68	CB740KIT \$825.58	CB840KIT \$937.80
45'	CB345KIT \$580.19	CB445KIT \$582.10	CB545KIT \$650.59	CB5.545KIT \$749.48	CB645KIT \$795.14	CB745KIT \$911.17	CB845KIT \$1,036.73
50'	CB350KIT \$622.01	CB450KIT \$623.93	CB550KIT \$700.02	CB5.550KIT \$802.76	CB650KIT \$861.72	CB750KIT \$983.47	CB850KIT \$1,137.54

M-Flex Kits

M-Flex

Basic Liner Kit

Made with the same upstanding quality as our CB Standard Kit; this kit is specialized for fireplace insert applications where a tee and tee end cap are not needed. This kit has been outfitted with our stove adapter designed by those in the field. Made to accept our liner into the top female end with our EZ clamp to tighten it in place. The stove adapter slips into the top of the stove or insert's collar for an easy transition to the stove or other application.



KIT INCLUDES:

- A Stainless steel liner**
UL 1777 Listed and
Tested all fuel
316 .006" (CB)
- B Top kit** which includes
a rain cap, and a
13"x13" top plate
- C Stove adapter**

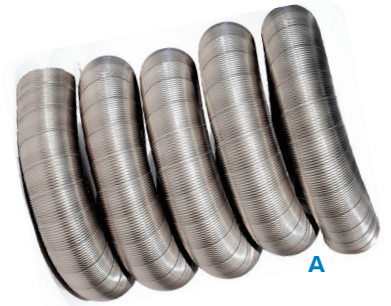

M-Flex

Pellet/Corn Liner Kit

The pellet/corn kits are similar to our Standard Kits and our Basic Kits. The primary difference is the short body tee that goes at the bottom of the liner. Each pellet tee is designed specifically to connect our liner to the pellet stove. Insert the liner into the top of the tee body, tighten the clamps, and put the snout around the outside of the pellet stove opening.

KIT INCLUDES:

- A Stainless steel liner**
UL 1777 Listed and
Tested all fuel 316
.006" (CB)
- B Top kit** which includes
a rain cap, and a 13"x13"
top plate
- C Pellet tee**
- D Tee end cap** 316



M-Flex

Aluminum Liner Kit

National Chimney manufactures our M-FLEX aluminum liner kits for appliances with A.F.U.E. of 83% or lower. Each aluminum kit comes professionally packed, includes installation instructions, and come with a 25-Year Warranty.



KIT INCLUDES:

- A 2-ply Aluminum Liner**
- B Mortar collar** aluminum
- C Aluminum cap**
- D Top plate** aluminum, 16"x16" plate and 2" high collar around the hole diameter

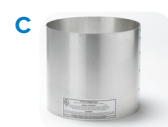
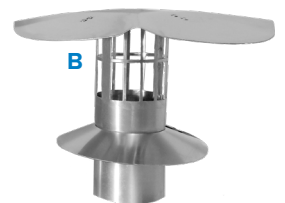

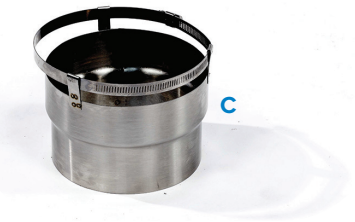
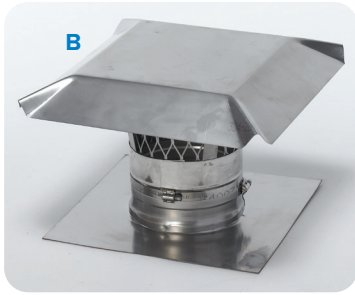

	3"	4"	5"	5.5"	6"	7"	8"
15'	CB315BK \$195.39	CB415BK \$217.72	CB515BK \$273.79	CB5.515BK \$298.74	CB615BK \$316.79	CB715BK \$375.60	CB815BK \$435.61
20'	CB320BK \$240.20	CB420BK \$309.63	CB520BK \$321.47	CB5.520BK \$378.13	CB620BK \$398.57	CB720BK \$435.62	CB820BK \$487.93
25'	CB325BK \$299.62	CB425BK \$344.55	CB525BK \$359.52	CB5.525BK \$407.47	CB625BK \$455.41	CB725BK \$479.37	CB825BK \$566.25
30'	CB330BK \$366.19	CB430BK \$396.97	CB530BK \$446.40	CB5.530BK \$489.87	CB630BK \$546.47	CB730BK \$585.73	CB830BK \$617.19
35'	CB335BK \$399.48	CB435BK \$449.41	CB535BK \$533.31	CB5.535BK \$572.24	CB635BK \$611.21	CB735BK \$668.14	CB835BK \$692.08
50'	CB350BK \$534.94	CB450BK \$536.58	CB550BK \$602.03	CB5.550BK \$690.37	CB650BK \$741.08	CB750BK \$845.77	CB850BK \$977.78

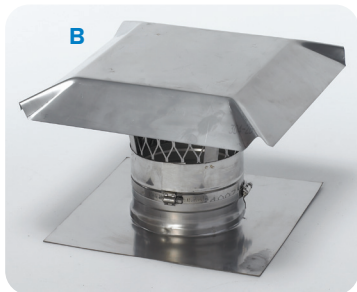

	3"	4"
25'	CB325KITP \$410.90	CB425KITP \$432.99
35'	CB335KITP \$494.59	CB435KITP \$496.49



The 3" pellet tee (NC3FXTPSB) accepts 3" liner and has a 3" diameter snout that is 2.5" long. The 4" pellet tee (NC4FXTPSB) accepts 4" liner and has 3" diameter snout.



	3"	4"	5"	5.5"	6"	7"	8"
10' Extension	DB310EXT \$35.72	DB410EXT \$42.86	DB510EXT \$55.25	DB5.510EXT \$59.46	DB610EXT \$62.57	DB710EXT \$69.65	DB810EXT \$79.15
25'	DB325KIT \$91.09	DB425KIT \$97.03	DB525KIT \$142.36	DB5.525KIT \$154.76	DB625KIT \$167.17	DB725KIT \$202.76	DB825KIT \$231.48
30'	DB330KIT \$100.76	DB430KIT \$107.78	DB530KIT \$158.86	DB5.530KIT \$166.80	DB630KIT \$180.97	DB730KIT \$227.48	DB830KIT \$264.57
35'	DB335KIT \$111.91	DB435KIT \$118.48	DB535KIT \$175.37	DB5.535KIT \$185.08	DB635KIT \$194.76	DB735KIT \$252.43	DB835KIT \$293.51
50'	DB350KIT \$142.69	DB450KIT \$174.19	DB550KIT \$215.49	DB5.550KIT \$236.14	DB650KIT \$256.79	DB750KIT \$327.21	DB850KIT \$382.40

M-Flex Liners

M-Flex 316 Liner

M-Flex liner is made from 316L stainless steel and is designed to reline existing chimneys or to be used in new construction. National Chimney manufactures the M-FLEX liner from the highest grade mill certified stainless steel alloy. It is made from a continuous strip of 7-ply stainless steel that is interlocked and crimped to produce a gas and watertight lining system of superior strength and durability. Its corrugated construction allows for expansion and contraction during heat up and cool down periods, removing any stress on the system.



- Made from .006" stainless steel, thicker and stronger than standard .005" liner.
- Lifetime transferable warranty when properly maintained by a chimney professional.
- UL listed (UL1777, UL64, UL441) for insulation and approved for all fuel types: wood, coal, oil, corn, and gas.



M-FLEX liner is available in interior dimension (ID) and outside dimension (OD)

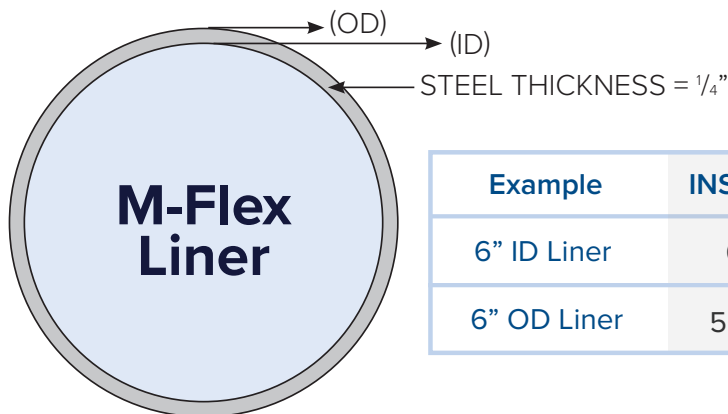

Example	INSIDE	OUTSIDE
6" ID Liner	6"	6¼"
6" OD Liner	5¾"	6"

*TAKE NOTE:
Standard liner lengths of 20' and longer include a 5% discount.*

6, 7, & 8 inch diameters are also available in OD. For ordering OD liners, please add "OD" to the end of the item # above. For Example, CB625OD

WHY CUSTOMERS LOVE NATIONAL CHIMNEY

“National Chimney has been our supplier of choice for over 15 years. **Quality craftsmanship, superior technical support, and first-class customer service.** Their commitment to assisting in our success has been unmatched. We couldn't ask for a better relationship with a supplier.”

- Rick Anderson, Anderson's Chimney

MANUFACTURED WITH .006 (CB) THICK STAINLESS STEEL LINER
UL LISTED UP TO 40" DIAMETER. CALL FOR PRICING ON 13"- 40".

Please Note: Prices do not include a coupler.

	3"	4"	5"	5.5"	6"	7"	8"	9"	10"	11"	12"
Per Foot	CB3ID \$9.76	CB4ID \$11.99	CB5ID \$14.68	CB5.5ID \$16.15	CB6ID \$17.63	CB7ID \$20.57	CB8ID \$23.52	CB9ID \$27.92	CB10ID \$31.05	CB11ID \$34.13	CB12ID \$37.25
5'	CB35 \$48.75	CB45 \$59.93	CB55 \$73.45	CB5.55 \$80.79	CB65 \$88.15	CB75 \$102.84	CB85 \$117.55	CB95 \$139.68	CB105 \$155.22	CB115 \$170.74	CB125 \$186.20
10'	CB310 \$97.53	CB410 \$119.86	CB510 \$146.87	CB5.510 \$161.59	CB610 \$176.30	CB710 \$205.70	CB810 \$235.12	CB910 \$279.36	CB1010 \$310.42	CB1110 \$341.47	CB1210 \$372.37
15'	CB315 \$145.76	CB415 \$179.82	CB515 \$220.33	CB5.515 \$242.38	CB615 \$264.44	CB715 \$308.54	CB815 \$352.66	CB915 \$419.04	CB1015 \$465.62	CB1115 \$512.21	CB1215 \$558.59
20'	CB320 \$188.31	CB420 \$227.77	CB520 \$279.08	CB5.520 \$307.01	CB620 \$334.95	CB720 \$390.82	CB820 \$446.81	CB920 \$530.78	CB1020 \$589.78	CB1120 \$648.82	CB1220 \$707.52
25'	CB325 \$231.62	CB425 \$284.69	CB525 \$348.86	CB5.525 \$383.77	CB625 \$418.68	CB725 \$442.42	CB825 \$523.10	CB925 \$597.14	CB1025 \$663.50	CB1125 \$811.02	CB1225 \$884.41
30'	CB330 \$277.95	CB430 \$341.66	CB530 \$418.62	CB5.530 \$460.53	CB630 \$502.43	CB730 \$541.09	CB830 \$570.17	CB930 \$796.20	CB1030 \$884.71	CB1130 \$973.22	CB1230 \$1,061.29
35'	CB335 \$324.26	CB435 \$398.60	CB535 \$488.40	CB5.535 \$537.27	CB635 \$586.16	CB735 \$617.22	CB835 \$639.63	CB935 \$928.89	CB1035 \$1,032.15	CB1135 \$1,135.41	CB1235 \$1,238.19
40'	CB340 \$370.59	CB440 \$426.49	CB540 \$507.93	CB5.540 \$566.84	CB640 \$615.49	CB740 \$678.94	CB840 \$735.56	CB940 \$1,061.59	CB1040 \$1,179.60	CB1140 \$1,297.61	CB1240 \$1,415.06
45'	CB345 \$416.91	CB445 \$456.36	CB545 \$627.90	CB5.545 \$597.98	CB645 \$646.24	CB745 \$746.81	CB845 \$845.88	CB945 \$1,194.26	CB1045 \$1,327.06	CB1145 \$1,459.82	CB1245 \$1,591.95
50'	CB350 \$463.23	CB450 \$485.48	CB550 \$544.68	CB5.550 \$624.61	CB650 \$684.61	CB750 \$781.34	CB850 \$903.26	CB950 \$1,326.97	CB1050 \$1,474.49	CB1150 \$1,622.02	CB1250 \$1,768.81
100'	CB3100 \$926.46	CB4100 \$970.96	CB5100 \$1,089.36	CB5.5100 \$1,229.27	CB6100 \$1,369.21	CB7100 \$1,562.66	CB8100 \$1,806.55				

	13"	14"	16"	18"
Per Foot	CB13ID \$40.32	CB14ID \$43.45	CB16ID \$49.65	CB18ID \$58.84

VETERAN OWNED

SERVING YOU FOR OVER -
30 YEARS
- NATIONAL CHIMNEY



M-Flex Smoothwall

Smoothwall

Standard Liner Kit

M-FLEX Smoothwall Standard Liner Kit is used for the same applications as the standard M-FLEX Liner Kit. However, the Smoothwall Standard Liner Kit offers superior flexibility with a higher BTU capacity. Each Smoothwall Standard Kit comes with installation instructions and a lifetime warranty. We stock 3" - 8" inside diameter (ID) kits.



KIT INCLUDES:

- A Stainless steel liner**
UL 1777 Listed and Tested all fuel 316 .006" (CB)
- B Top kit** which includes a rain cap, and a 13"x13" top plate
- C Two part tee** with removable 10" take off (snout) 316
- D Tee end cap** 316

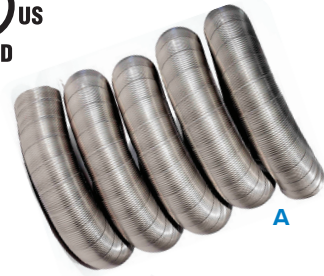

Smoothwall

Basic Liner Kit

Made with the same quality as our Smoothwall Standard Liner Kit; this kit is specialized for fireplace insert applications where a tee and tee end cap are not needed. This kit has been outfitted with our stove adapter. The stove adapter accepts our liner into the top female end with our EZ clamp to tighten it in place and slips into the top of a stove or insert collar.

KIT INCLUDES:

- A Stainless steel liner**
UL 1777 Listed and Tested all fuel 316 .006" (CB)
- B Top kit** which includes a rain cap, and a 13"x13" top plate
- C Stove Adapter**



Smoothwall

316 Liner

National Chimney's Smoothwall Liner (SW) has superior flexibility with a high BTU capacity. Its smooth interior allows for more airflow, reducing drag by 20% over traditional corrugated liners. Smoothwall is made from 2-ply 316 stainless steel which makes it ideal for any application. It is compatible with our all fuel components as well as our wood or wood pellet components.



SMOOTH INTERIOR DESIGN ALLOWS MORE AIR FLOW

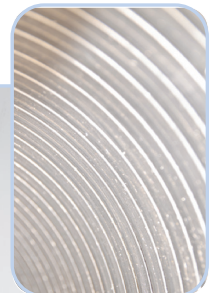

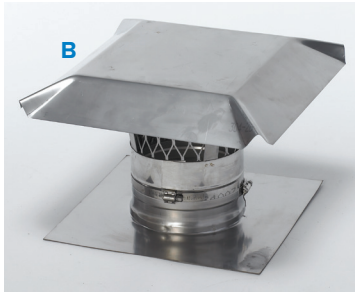

	3"	4"	5"	5.5"	6"	7"	8"
15'	SW315KIT \$296.84	SW415KIT \$332.14	SW515KIT \$401.66	SW5.515KIT \$430.40	SW615KIT \$463.28	SW715KIT \$550.77	SW815KIT \$600.78
20'	SW320KIT \$324.82	SW420KIT \$364.87	SW520KIT \$444.92	SW5.520KIT \$484.96	SW620KIT \$524.99	SW720KIT \$605.05	SW820KIT \$685.10
25'	SW325KIT \$384.37	SW425KIT \$434.41	SW525KIT \$534.48	SW5.525KIT \$584.53	SW625KIT \$634.57	SW725KIT \$734.62	SW825KIT \$834.72
30'	SW330KIT \$443.93	SW430KIT \$503.96	SW530KIT \$624.06	SW5.530KIT \$684.10	SW630KIT \$744.15	SW730KIT \$864.22	SW830KIT \$984.33
35'	SW335KIT \$503.46	SW435KIT \$573.53	SW535KIT \$713.61	SW5.535KIT \$783.68	SW635KIT \$853.73	SW735KIT \$993.82	SW835KIT \$1,133.95
50'	SW350KIT \$682.09	SW450KIT \$782.17	SW550KIT \$982.31	SW5.550KIT \$1,082.37	SW650KIT \$1,182.47	SW750KIT \$1,382.63	SW850KIT \$1,582.75

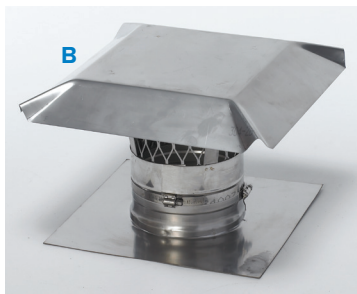

	3"	4"	5"	5.5"	6"	7"	8"
15'	SW315BK \$202.29	SW415BK \$232.29	SW515BK \$292.34	SW5.515BK \$322.36	SW615BK \$352.38	SW715BK \$412.42	SW815BK \$472.47
20'	SW320BK \$261.82	SW420BK \$301.86	SW520BK \$429.18	SW5.520BK \$421.92	SW620BK \$461.96	SW720BK \$542.02	SW820BK \$622.10
25'	SW325BK \$321.36	SW425BK \$371.39	SW525BK \$471.49	SW5.525BK \$521.50	SW625BK \$571.56	SW725BK \$671.62	SW825BK \$771.71
30'	SW330BK \$380.91	SW430BK \$440.93	SW530BK \$561.02	SW5.530BK \$621.10	SW630BK \$681.12	SW730BK \$801.20	SW830BK \$921.30
35'	SW335BK \$440.45	SW435BK \$510.50	SW535BK \$650.61	SW5.535BK \$720.64	SW635BK \$790.72	SW735BK \$930.82	SW835BK \$1,070.93
50'	SW350BK \$619.06	SW450BK \$719.16	SW550BK \$919.31	SW5.550BK \$1,019.36	SW650BK \$1,119.44	SW750BK \$1,319.59	SW850BK \$1,519.74

	3"	4"	5"	5.5"	6"	7"	8"	9"	10"	11"	12"
5'	SW35L \$59.57	SW45L \$69.57	SW55L \$89.58	SW5.55L \$99.62	SW65L \$109.57	SW75L \$129.60	SW85L \$149.61	SW95L \$169.64	SW105L \$189.66	SW115L \$209.67	SW125L \$229.67
10'	SW310L \$119.08	SW410L \$139.10	SW510L \$179.14	SW5.510L \$199.15	SW610L \$219.18	SW710L \$259.19	SW810L \$299.23	SW910L \$339.24	SW1010L \$379.27	SW1110L \$419.33	SW1210L \$459.35
15'	SW315L \$178.65	SW415L \$208.64	SW515L \$268.72	SW5.515L \$298.73	SW615L \$328.75	SW715L \$388.81	SW815L \$448.83	SW915L \$508.87	SW1015L \$568.92	SW1115L \$628.98	SW1215L \$689.01
20'	SW320L \$238.18	SW420L \$278.22	SW520L \$358.28	SW5.520L \$398.32	SW620L \$438.34	SW720L \$518.39	SW820L \$598.47	SW920L \$678.53	SW1020L \$758.59	SW1120L \$838.62	SW1220L \$918.70
25'	SW325L \$297.74	SW425L \$347.76	SW525L \$447.84	SW5.525L \$497.87	SW625L \$547.94	SW725L \$648.00	SW825L \$748.10	SW925L \$848.14	SW1025L \$948.21	SW1125L \$1,048.29	SW1225L \$1,148.37
30'	SW330L \$357.29	SW430L \$417.31	SW530L \$537.40	SW5.530L \$597.45	SW630L \$657.51	SW730L \$777.58	SW830L \$897.68	SW930L \$1,017.76	SW1030L \$1,137.86	SW1130L \$1,257.96	SW1230L \$1,378.02
35'	SW335L \$416.80	SW435L \$486.87	SW535L \$626.99	SW5.535L \$697.01	SW635L \$767.09	SW735L \$907.18	SW835L \$1,047.30	SW935L \$1,187.39	SW1035L \$1,327.51	SW1135L \$1,467.60	SW1235L \$1,607.71
50'	SW350L \$595.43	SW450L \$695.53	SW550L \$895.68	SW5.550L \$995.73	SW650L \$1,095.82	SW750L \$1,295.98	SW850L \$1,496.12	SW950L \$1,696.27	SW1050L \$1,896.41	SW1150L \$2,096.56	SW1250L \$2,296.71

M-Flex Pre-Insulated

PRE-INSULATED M-FLEX LINERS WITH STAINLESS OR ALUMINUM OUTER SHELL

National Chimney offers pre-insulated M-Flex chimney liners with your choice of Stainless or Aluminum outer protective liner. The Aluminum outer liner offers better flexibility and ease of handling, whereas the Stainless Steel outer liner offers durability. Both are manufactured using our highest quality, mill certified 316L Stainless Steel M-Flex inner liner and our 1/2" insulation wrap. This convenient liner will save you time and frustration on the job. Most liners can ship FedEx Ground. Liners of 8" or larger diameters ship via common carrier. These liners are also available in our Standard and Basic Kits.

Stainless Steel Pre-Insulated Standard Outer Liner Kit



	25'	30'	35'	40'	45'	50'
5"	CBP525KIT \$835.55	CBP530KIT \$955.86	CBP535KIT \$1,061.73	CBP540KIT \$1,219.15	CBP545KIT \$1,328.83	CBP550KIT \$1,480.83
5.5"	CBP5.525KIT \$848.96	CBP5.530KIT \$958.64	CBP5.535KIT \$1,067.32	CBP5.540KIT \$1,228.71	CBP5.545KIT \$1,340.56	CBP5.550KIT \$1,512.33
6"	CBP625KIT \$864.86	CBP630KIT \$965.53	CBP635KIT \$1,075.30	CBP640KIT \$1,238.75	CBP645KIT \$1,350.67	CBP650KIT \$1,560.02
7"	CBP725KIT \$1,100.39	CBP730KIT \$1,185.26	CBP735KIT \$1,347.32	CBP740KIT \$1,551.65	CBP745KIT \$1,653.45	CBP750KIT \$1,797.43
8"	CBP825KIT \$1,212.99	CBP830KIT \$1,421.40	CBP835KIT \$1,611.24	CBP840KIT \$1,850.06	CBP845KIT \$2,033.01	CBP850KIT \$2,221.02

Stainless Steel Pre-Insulated Basic Outer Liner Kit



	25'	30'	35'	40'	45'	50'
5"	CBP525BK \$815.25	CBP530BK \$905.03	CBP535BK \$1,013.58	CBP540BK \$1,173.64	CBP545BK \$1,285.88	CBP550BK \$1,433.58
5.5"	CBP5.525BK \$818.00	CBP5.530BK \$912.05	CBP5.535BK \$1,016.11	CBP5.540BK \$1,178.27	CBP5.545BK \$1,292.60	CBP5.550BK \$1,465.73
6"	CBP625BK \$820.34	CBP630BK \$914.49	CBP635BK \$1,019.73	CBP640BK \$1,182.28	CBP645BK \$1,301.15	CBP650BK \$1,521.96
7"	CBP725BK \$1,038.82	CBP730BK \$1,146.79	CBP735BK \$1,297.11	CBP740BK \$1,494.08	CBP745BK \$1,609.07	CBP750BK \$1,751.73
8"	CBP825BK \$1,153.12	CBP830BK \$1,367.39	CBP835BK \$1,555.58	CBP840BK \$1,782.11	CBP845BK \$1,969.86	CBP850BK \$2,158.24

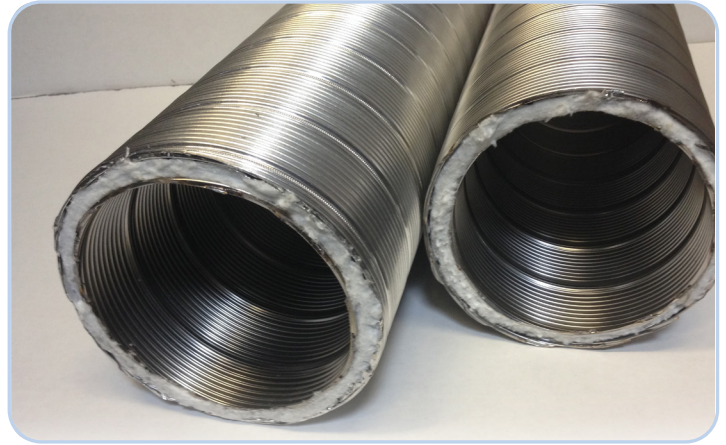

Aluminum Pre-Insulated Standard Outer Liner Kit



	25'	30'	35'	40'	45'	50'
5"	DBP525KIT \$716.20	DBP530KIT \$851.40	DBP535KIT \$955.36	DBP540KIT \$1,080.09	DBP545KIT \$1,195.98	DBP550KIT \$1,330.78
5.5"	DBP5.525KIT \$730.54	DBP5.530KIT \$864.30	DBP5.535KIT \$970.33	DBP5.540KIT \$1,115.14	DBP5.545KIT \$1,250.00	DBP5.550KIT \$1,389.88
6"	DBP625KIT \$748.20	DBP630KIT \$874.29	DBP635KIT \$974.42	DBP640KIT \$1,142.74	DBP645KIT \$1,264.11	DBP650KIT \$1,407.37
7"	DBP725KIT \$996.24	DBP730KIT \$1,082.57	DBP735KIT \$1,255.48	DBP740KIT \$1,389.82	DBP745KIT \$1,495.54	DBP750KIT \$1,640.98
8"	DBP825KIT \$1,113.47	DBP830KIT \$1,334.24	DBP835KIT \$1,494.37	DBP840KIT \$1,705.11	DBP845KIT \$1,898.38	DBP850KIT \$2,097.05

Aluminum Pre-Insulated Basic Outer Liner Kit



	25'	30'	35'	40'	45'	50'
5"	DBP525BK \$697.37	DBP530BK \$791.50	DBP535BK \$902.85	DBP540BK \$1,032.01	DBP545BK \$1,110.64	DBP550BK \$1,265.04
5.5"	DBP5.525BK \$704.51	DBP5.530BK \$813.87	DBP5.535BK \$907.17	DBP5.540BK \$1,036.93	DBP5.545BK \$1,116.08	DBP5.550BK \$1,298.99
6"	DBP625BK \$714.84	DBP630BK \$824.78	DBP635BK \$912.65	DBP640BK \$1,041.14	DBP645BK \$1,125.15	DBP650BK \$1,361.77
7"	DBP725BK \$932.00	DBP730BK \$1,042.84	DBP735BK \$1,197.20	DBP740BK \$1,370.57	DBP745BK \$1,450.49	DBP750BK \$1,601.20
8"	DBP825BK \$1,052.73	DBP830BK \$1,275.78	DBP835BK \$1,473.63	DBP840BK \$1,674.93	DBP845BK \$1,830.99	DBP850BK \$2,029.88

M-Flex Pre-Insulated

Pre-Insulated

Stainless Steel Outer Liner



	25'	30'	35'	40'	45'	50'
5"	CBP525 \$691.55	CBP530 \$807.50	CBP535 \$916.35	CBP540 \$1,084.73	CBP545 \$1,199.45	CBP550 \$1,360.25
5.5"	CBP5.525 \$697.10	CBP5.530 \$813.82	CBP5.535 \$926.28	CBP5.540 \$1,096.28	CBP5.545 \$1,215.96	CBP5.550 \$1,393.74
6"	CBP625 \$713.23	CBP630 \$819.58	CBP635 \$951.45	CBP640 \$1,106.66	CBP645 \$1,226.42	CBP650 \$1,446.00
7"	CBP725 \$851.48	CBP730 \$1,031.00	CBP735 \$1,200.82	CBP740 \$1,349.13	CBP745 \$1,522.94	CBP750 \$1,670.66
8"	CBP825 \$996.45	CBP830 \$1,205.09	CBP835 \$1,394.59	CBP840 \$1,602.06	CBP845 \$1,816.80	CBP850 \$2,006.23

Per Foot

3"	CBP3ID \$21.88
4"	CBP4ID \$25.03
5"	CBP5ID \$28.19
5.5"	CBP5.5ID \$29.40
6"	CBP6ID \$29.76
7"	CBP7ID \$35.19
8"	CBP8ID \$40.56
9"	CBP9ID \$46.86
10"	CBP10ID \$53.16
11"	CBP11ID \$59.47

Pre-Insulated

Aluminum Outer Liner



	25'	30'	35'	40'	45'	50'
5"	DBP525 \$561.79	DBP530 \$685.33	DBP535 \$799.55	DBP540 \$976.92	DBP545 \$1,098.27	DBP550 \$1,119.06
5.5"	DBP5.525 \$568.02	DBP5.530 \$692.26	DBP5.535 \$809.72	DBP5.540 \$989.41	DBP5.545 \$1,107.61	DBP5.550 \$1,131.05
6"	DBP625 \$583.00	DBP630 \$698.10	DBP635 \$836.80	DBP640 \$999.14	DBP645 \$1,125.76	DBP650 \$1,147.70
7"	DBP725 \$731.26	DBP730 \$919.24	DBP735 \$1,098.59	DBP740 \$1,255.48	DBP745 \$1,405.35	DBP750 \$1,446.97
8"	DBP825 \$882.63	DBP830 \$1,102.58	DBP835 \$1,302.16	DBP840 \$1,523.04	DBP845 \$1,706.99	DBP850 \$1,731.95

Per Foot

3"	DBP3ID \$17.90
4"	DBP4ID \$19.56
5"	DBP5ID \$21.39
5.5"	DBP5.5ID \$23.24
6"	DBP6ID \$23.39
7"	DBP7ID \$29.55
8"	DBP8ID \$36.62
9"	DBP9ID \$44.51
10"	DBP10ID \$52.01
11"	DBP11ID \$59.93



Pre-Insulated

Finishing Plug

This plug is used to complete the chimney termination of a Pre-Insulated Liner. The collar with the band on the outside fits over the outer liner. The smaller collar is designed to accept the inner liner. To finish the installation, you can purchase a "Top Kit Rain Cap" which easily connects to the smaller collar with the same EZ Band Clamp connection. Made from 24ga 304 stainless steel.

3"	NC3PIFP	\$51.28
4"	NC4PIFP	\$56.01
5"	NC5PIFP	\$60.74
5.5"	NC5.5PIFP	\$65.46
6"	NC6PIFP	\$65.46
7"	NC7PIFP	\$70.18
8"	NC8PIFP	\$74.91
9"	NC9PIFP	\$79.64
10"	NC10PIFP	\$84.35
11"	NC11PIFP	\$89.09



Pre-Insulated

Stove Adapter

This adapter is used to connect the Pre-Insulated Liner to your wood stove or insert. The Pre-Insulated liner fits fully into the large end of the adapter and the EZ Band Clamp secures the liner in place. The small end collar is crimped to fit inside the appliance's stove collar. Made from 24ga 304 stainless steel.

3"	NC3PISA	\$41.46
4"	NC4PISA	\$46.19
5"	NC5PISA	\$50.91
5.5"	NC5.5PISA	\$55.64
6"	NC6PISA	\$55.64
7"	NC7PISA	\$60.36
8"	NC8PISA	\$65.07
9"	NC9PISA	\$69.82
10"	NC10PISA	\$69.82
11"	NC11PISA	\$77.86



Pre-Insulated

Liner Coupler

This coupler is used to join (2) pieces of Pre-Insulated Liner together. It is designed to provide a dripless connection having both a female and a male end. The EZ Clamp Bands on both ends of the coupler ensures a secure connection on both ends of the liner. It is made from 24ga 316 stainless steel so it can be used for wood, oil, gas, and coal applications.

3"	NC3PICL	\$42.53
4"	NC4PICL	\$44.11
5"	NC5PICL	\$45.68
5.5"	NC5.5PICL	\$47.25
6"	NC6PICL	\$48.82
7"	NC7PICL	\$50.40
8"	NC8PICL	\$51.98
9"	NC9PICL	\$53.57
10"	NC10PICL	\$55.13
11"	NC11PICL	\$56.72

M-Flex Plus

INTRODUCING THE NEW M-FLEX PLUS



It's more flexible than our standard M-Flex Liner which makes it perfect for navigating through offsets. Used for wood, oil, coal, and gas appliances. UL 1777 Listed and Tested all fuel 316 .005" stainless steel liner. Each M-Flex Plus Kit comes with installation instructions and a lifetime warranty. M-Flex Plus adapter required. Adapter is included in standard lengths and kits.



M-Flex Plus **Standard Liner Kit**

	5"	5.5"	6"	7"	8"
15'	MFP515KIT \$417.85	MFP5.515KIT \$453.05	MFP615KIT \$476.77	MFP715KIT \$558.57	MFP815KIT \$602.32
20'	MFP520KIT \$456.55	MFP5.520KIT \$502.20	MFP620KIT \$526.10	MFP720KIT \$610.89	MFP820KIT \$684.80
25'	MFP525KIT \$529.22	MFP5.525KIT \$571.75	MFP625KIT \$608.27	MFP725KIT \$693.49	MFP825KIT \$782.63
30'	MFP530KIT \$577.51	MFP5.530KIT \$667.59	MFP630KIT \$681.20	MFP730KIT \$776.13	MFP830KIT \$878.31
35'	MFP535KIT \$625.82	MFP5.535KIT \$708.74	MFP635KIT \$777.35	MFP735KIT \$858.72	MFP835KIT \$973.94
40'	MFP540KIT \$678.28	MFP5.540KIT \$789.15	MFP640KIT \$830.48	MFP740KIT \$943.52	MFP840KIT \$1,071.79
45'	MFP545KIT \$743.52	MFP5.545KIT \$856.54	MFP645KIT \$908.75	MFP745KIT \$1,041.33	MFP845KIT \$1,184.84
50'	MFP550KIT \$800.04	MFP5.550KIT \$917.43	MFP650KIT \$984.82	MFP750KIT \$1,123.97	MFP850KIT \$1,300.06

M-Flex Plus **Basic Liner Kit**

	5"	5.5"	6"	7"	8"
15'	MFP515BK \$312.89	MFP5.515BK \$341.44	MFP615BK \$362.03	MFP715BK \$429.25	MFP815BK \$497.82
20'	MFP520BK \$367.41	MFP5.520BK \$432.15	MFP620BK \$455.49	MFP720BK \$497.83	MFP820BK \$557.66
25'	MFP525BK \$410.88	MFP5.525BK \$465.69	MFP625BK \$520.46	MFP725BK \$547.84	MFP825BK \$647.15
30'	MFP530BK \$510.17	MFP5.530BK \$559.86	MFP630BK \$624.55	MFP730BK \$669.41	MFP830BK \$705.37
35'	MFP535BK \$609.51	MFP5.535BK \$653.98	MFP635BK \$698.52	MFP735BK \$763.57	MFP835BK \$790.95
50'	MFP550BK \$688.02	MFP5.550BK \$789.00	MFP650BK \$846.95	MFP750BK \$966.61	MFP850BK \$1,117.45

M-Flex Plus **Liners**

	5"	5.5"	6"	7"	8"
1'	MFP5ID \$17.63	MFP5.5ID \$19.39	MFP6ID \$21.17	MFP7ID \$24.68	MFP8ID \$28.22
5'	MFP55 \$88.14	MFP5.55 \$96.95	MFP65 \$105.90	MFP75 \$123.42	MFP85 \$141.05
10'	MFP510 \$176.26	MFP5.510 \$193.91	MFP610 \$211.55	MFP710 \$246.84	MFP810 \$282.11
15'	MFP515 \$264.40	MFP5.515 \$290.85	MFP615 \$317.33	MFP715 \$370.25	MFP815 \$423.19
20'	MFP520 \$334.89	MFP5.520 \$368.41	MFP620 \$401.94	MFP720 \$468.98	MFP820 \$536.17
25'	MFP525 \$418.60	MFP5.525 \$460.53	MFP625 \$502.42	MFP725 \$530.90	MFP825 \$627.73
30'	MFP530 \$502.36	MFP5.530 \$552.63	MFP630 \$602.94	MFP730 \$649.29	MFP830 \$684.22
35'	MFP535 \$586.07	MFP5.535 \$644.73	MFP635 \$695.90	MFP735 \$740.66	MFP835 \$767.55
40'	MFP540 \$609.52	MFP5.540 \$680.20	MFP640 \$738.56	MFP740 \$814.72	MFP840 \$882.65
45'	MFP545 \$753.46	MFP5.545 \$717.58	MFP645 \$775.49	MFP745 \$896.19	MFP845 \$1,015.05
50'	MFP550 \$653.62	MFP5.550 \$749.55	MFP650 \$821.52	MFP750 \$937.59	MFP850 \$1,083.91
100'	MFP5100 \$1,307.25	MFP5.5100 \$1,475.31	MFP6100 \$1,643.05	MFP7100 \$1,875.20	MFP8100 \$2,167.84
	9"	10"	11"	12"	
1'	MFP9ID \$33.51	MFP10ID \$37.26	MFP11ID \$40.98	MFP12ID \$44.68	
5'	MFP95 \$167.62	MFP105 \$186.26	MFP115 \$204.89	MFP125 \$223.42	
10'	MFP910 \$335.25	MFP1010 \$372.51	MFP1110 \$409.77	MFP1210 \$446.86	
15'	MFP915 \$502.84	MFP1015 \$558.76	MFP1115 \$614.66	MFP1215 \$670.28	
20'	MFP920 \$636.95	MFP1020 \$707.75	MFP1120 \$778.58	MFP1220 \$849.04	
25'	MFP925 \$716.56	MFP1025 \$796.21	MFP1125 \$973.22	MFP1225 \$1,061.30	
30'	MFP930 \$955.43	MFP1030 \$1,061.64	MFP1130 \$1,167.84	MFP1230 \$1,273.56	
35'	MFP935 \$1,114.66	MFP1035 \$1,238.58	MFP1135 \$1,362.49	MFP1235 \$1,485.81	
40'	MFP940 \$1,341.40	MFP1040 \$1,415.51	MFP1140 \$1,557.15	MFP1240 \$1,698.09	
45'	MFP945 \$1,433.11	MFP1045 \$1,592.46	MFP1145 \$1,751.77	MFP1245 \$1,910.33	
50'	MFP950 \$1,592.36	MFP1050 \$1,769.42	MFP1150 \$1,946.41	MFP1250 \$2,122.59	

M-Flex Premier

PREMIER FLEX HEAVYWALL

Premier Flex is extremely durable and made from .015 Stainless Steel. It features an interlocked design to maximize strength and flexibility. It's the most rugged liner we recommend for those tight winch-able situations. Each Premier Flex Heavywall Kit comes with installation instructions and a lifetime warranty.

Premier Flex Heavywall

Standard Liner Kit



NCPR KIT 304		NCPR KIT 316	
NCPR515KIT	\$500.14	NCPR515KITL	\$703.53
NCPR520KIT	\$605.64	NCPR520KITL	\$876.79
NCPR525KIT	\$711.07	NCPR525KITL	\$1,050.06
NCPR530KIT	\$816.55	NCPR530KITL	\$1,223.30
NCPR535KIT	\$922.00	NCPR535KITL	\$1,396.56
NCPR550KIT	\$1,238.37	NCPR550KITL	\$1,916.33
NCPR5.515KIT	\$535.22	NCPR5.515KITL	\$857.74
NCPR5.520KIT	\$648.20	NCPR5.520KITL	\$1,078.26
NCPR5.525KIT	\$761.20	NCPR5.525KITL	\$1,298.74
NCPR5.530KIT	\$874.17	NCPR5.530KITL	\$1,519.27
NCPR5.535KIT	\$987.18	NCPR5.535KITL	\$1,739.77
NCPR5.550KIT	\$1,326.16	NCPR5.550KITL	\$2,401.29
NCPR615KIT	\$535.22	NCPR615KITL	\$857.74
NCPR620KIT	\$648.20	NCPR620KITL	\$1,078.26
NCPR625KIT	\$761.20	NCPR625KITL	\$1,298.74
NCPR630KIT	\$874.17	NCPR630KITL	\$1,519.27
NCPR635KIT	\$987.18	NCPR635KITL	\$1,739.77
NCPR650KIT	\$1,326.16	NCPR650KITL	\$2,401.29
NCPR715KIT	\$650.12	NCPR715KITL	\$969.24
NCPR720KIT	\$795.75	NCPR720KITL	\$1,221.26
NCPR725KIT	\$941.40	NCPR725KITL	\$1,473.27
NCPR730KIT	\$1,087.03	NCPR730KITL	\$1,725.26
NCPR735KIT	\$1,232.68	NCPR735KITL	\$1,977.26
NCPR750KIT	\$1,669.56	NCPR750KITL	\$2,733.29
NCPR815KIT	\$679.70	NCPR815KITL	\$1,081.27
NCPR820KIT	\$829.37	NCPR820KITL	\$1,364.79
NCPR825KIT	\$979.02	NCPR825KITL	\$1,648.30
NCPR830KIT	\$1,128.65	NCPR830KITL	\$1,931.80
NCPR835KIT	\$1,278.32	NCPR835KITL	\$2,215.32
NCPR850KIT	\$1,727.29	NCPR850KITL	\$3,065.86

Premier Flex Heavywall

Basic Liner Kit



NCPR BK 304		NCPR BK 316	
NCPR515BK	\$431.12	NCPR515BKL	\$634.52
NCPR520BK	\$536.61	NCPR520BKL	\$807.77
NCPR525BK	\$642.05	NCPR525BKL	\$981.04
NCPR530BK	\$747.52	NCPR530BKL	\$1,154.29
NCPR535BK	\$852.98	NCPR535BKL	\$1,327.54
NCPR550BK	\$1,169.35	NCPR550BKL	\$1,847.30
NCPR5.515BK	\$442.17	NCPR5.515BKL	\$764.69
NCPR5.520BK	\$555.15	NCPR5.520BKL	\$985.22
NCPR5.525BK	\$668.15	NCPR5.525BKL	\$1,205.71
NCPR5.530BK	\$781.12	NCPR5.530BKL	\$1,426.22
NCPR5.535BK	\$894.14	NCPR5.535BKL	\$1,646.73
NCPR5.550BK	\$1,233.11	NCPR5.550BKL	\$2,308.26
NCPR615BK	\$461.31	NCPR615BKL	\$783.85
NCPR620BK	\$574.30	NCPR620BKL	\$1,004.36
NCPR625BK	\$687.30	NCPR625BKL	\$1,224.85
NCPR630BK	\$800.27	NCPR630BKL	\$1,445.36
NCPR635BK	\$913.29	NCPR635BKL	\$1,665.87
NCPR650BK	\$1,252.26	NCPR650BKL	\$2,327.40
NCPR715BK	\$569.04	NCPR715BKL	\$888.16
NCPR720BK	\$714.67	NCPR720BKL	\$1,140.18
NCPR725BK	\$860.32	NCPR725BKL	\$1,392.19
NCPR730BK	\$1,005.95	NCPR730BKL	\$1,644.18
NCPR735BK	\$1,151.61	NCPR735BKL	\$1,896.18
NCPR750BK	\$1,588.48	NCPR750BKL	\$2,652.22
NCPR815BK	\$592.38	NCPR815BKL	\$993.94
NCPR820BK	\$742.03	NCPR820BKL	\$1,277.46
NCPR825BK	\$891.68	NCPR825BKL	\$1,560.98
NCPR830BK	\$1,041.32	NCPR830BKL	\$1,844.46
NCPR835BK	\$1,190.98	NCPR835BKL	\$2,127.98
NCPR850BK	\$1,639.97	NCPR850BKL	\$2,978.54

Premier Flex Heavywall **316 (PRL) & 304 (PR) Liners**



Premier Flex is extremely durable and made from .015 Stainless Steel. It features an interlocked design to maximize strength and flexibility. It's the most rugged liner we recommend for those tight winch-able situations. Premier Flex 316 can be used for all fuel burning appliances including; wood, wood pellet, oil, gas, and corn. Premier Flex 304 can be used for wood burning appliances. Premier Flex can withstand being ovalized and rectanglized to accommodate for unusual offsets or rectangular chimneys. When a liner is taken "out of round" it does reduce the cross sectional area. If you need help sizing a liner, please call 800-897-8481.



*Not available in a kit; components are sold separately.

	3"	4"	5"	5.5"	6"	7"	8"	9"	10"	11"	12"
5'	NCPR35L	NCPR45L	NCPR55L	NCPR5.55L	NCPR65L	NCPR75L	NCPR85L	NCPR95L	NCPR105L	NCPR115L	NCPR125L
	\$128.34	\$169.18	\$192.50	\$245.02	\$245.02	\$280.00	\$315.02	\$361.68	\$408.33	\$455.01	\$478.37
	NCPR35	NCPR45	NCPR55	NCPR5.55	NCPR65	NCPR75	NCPR85	NCPR95	NCPR105	NCPR115	NCPR125
	\$83.71	\$100.45	\$117.17	\$125.57	\$125.57	\$161.81	\$166.29	\$212.04	\$223.19	\$256.67	\$290.14
10'	NCPR310L	NCPR410L	NCPR510L	NCPR5.510L	NCPR610L	NCPR710L	NCPR810L	NCPR910L	NCPR1010L	NCPR1110L	NCPR1210L
	\$256.67	\$338.34	\$385.03	\$490.01	\$490.01	\$560.02	\$630.00	\$723.37	\$816.71	\$910.04	\$956.71
	NCPR310	NCPR410	NCPR510	NCPR5.510	NCPR610	NCPR710	NCPR810	NCPR910	NCPR1010	NCPR1110	NCPR1210
	\$167.41	\$200.88	\$234.34	\$251.09	\$251.09	\$323.64	\$332.58	\$424.06	\$446.39	\$513.36	\$580.31
15'	NCPR315L	NCPR415L	NCPR515L	NCPR5.515L	NCPR615L	NCPR715L	NCPR815L	NCPR915L	NCPR1015L	NCPR1115L	NCPR1215L
	\$385.03	\$485.46	\$577.52	\$735.03	\$735.03	\$840.04	\$945.03	\$1,085.04	\$1,225.03	\$1,365.05	\$1,435.07
	NCPR315	NCPR415	NCPR515	NCPR5.515	NCPR615	NCPR715	NCPR815	NCPR915	NCPR1015	NCPR1115	NCPR1215
	\$251.09	\$301.33	\$351.53	\$376.66	\$376.66	\$485.46	\$498.85	\$636.12	\$669.58	\$770.03	\$870.46
20'	NCPR320L	NCPR420L	NCPR520L	NCPR5.520L	NCPR620L	NCPR720L	NCPR820L	NCPR920L	NCPR1020L	NCPR1120L	NCPR1220L
	\$513.36	\$676.69	\$770.03	\$980.04	\$980.04	\$1,120.05	\$1,260.05	\$1,446.71	\$1,633.41	\$1,820.05	\$1,913.40
	NCPR320	NCPR420	NCPR520	NCPR5.520	NCPR620	NCPR720	NCPR820	NCPR920	NCPR1020	NCPR1120	NCPR1220
	\$334.80	\$401.75	\$468.74	\$502.20	\$502.20	\$647.27	\$665.13	\$848.14	\$892.79	\$1,026.71	\$1,160.63
25'	NCPR325L	NCPR425L	NCPR525L	NCPR5.525L	NCPR625L	NCPR725L	NCPR825L	NCPR925L	NCPR1025L	NCPR1125L	NCPR1225L
	\$641.68	\$845.88	\$962.54	\$1,225.03	\$1,225.03	\$1,400.07	\$1,575.06	\$1,808.40	\$2,041.73	\$2,275.09	\$2,391.77
	NCPR325	NCPR425	NCPR525	NCPR5.525	NCPR625	NCPR725	NCPR825	NCPR925	NCPR1025	NCPR1125	NCPR1225
	\$418.50	\$502.20	\$585.89	\$627.75	\$627.75	\$809.10	\$831.41	\$1,060.20	\$1,115.98	\$1,283.38	\$1,450.78
30'	NCPR330L	NCPR430L	NCPR530L	NCPR5.530L	NCPR630L	NCPR730L	NCPR830L	NCPR930L	NCPR1030L	NCPR1130L	NCPR1230L
	\$770.03	\$1,015.03	\$1,155.04	\$1,470.05	\$1,470.05	\$1,680.05	\$1,890.05	\$2,170.10	\$2,450.08	\$2,730.09	\$2,870.12
	NCPR330	NCPR430	NCPR530	NCPR5.530	NCPR630	NCPR730	NCPR830	NCPR930	NCPR1030	NCPR1130	NCPR1230
	\$502.20	\$602.64	\$703.09	\$753.28	\$753.28	\$970.91	\$997.67	\$1,272.22	\$1,339.19	\$1,540.04	\$1,740.93
35'	NCPR335L	NCPR435L	NCPR535L	NCPR5.535L	NCPR635L	NCPR735L	NCPR835L	NCPR935L	NCPR1035L	NCPR1135L	NCPR1235L
	\$898.36	\$1,184.21	\$1,347.55	\$1,715.06	\$1,715.06	\$1,960.06	\$2,205.08	\$2,531.77	\$2,858.43	\$3,185.14	\$3,348.47
	NCPR335	NCPR435	NCPR535	NCPR5.535	NCPR635	NCPR735	NCPR835	NCPR935	NCPR1035	NCPR1135	NCPR1235
	\$585.89	\$703.09	\$820.26	\$878.85	\$878.85	\$1,132.75	\$1,163.96	\$1,484.25	\$1,562.37	\$1,796.75	\$2,031.10
50'	NCPR350L	NCPR450L	NCPR550L	NCPR5.550L	NCPR650L	NCPR750L	NCPR850L	NCPR950L	NCPR1050L	NCPR1150L	NCPR1250L
	\$1,283.38	\$1,691.73	\$1,925.07	\$2,450.08	\$2,450.08	\$2,800.10	\$3,150.13	\$3,616.80	\$4,083.49	\$4,550.17	\$4,783.49
	NCPR350	NCPR450	NCPR550	NCPR5.550	NCPR650	NCPR750	NCPR850	NCPR950	NCPR1050	NCPR1150	NCPR1250
	\$836.98	\$1,004.38	\$1,171.78	\$1,255.49	\$1,255.49	\$1,618.17	\$1,662.83	\$2,120.38	\$2,231.98	\$2,566.77	\$2,901.55

	13"		14"		16"		18"	
Per Foot	NCPR13	NCPR13L	NCPR14	NCPR14L	NCPR16	NCPR16L	NCPR18	NCPR18L
	\$65.08	\$103.85	\$71.96	\$111.62	\$85.93	\$136.88	\$95.98	\$143.50

M-Flex Premier

PREMIER LITE & FLEX LITE

As the chimney industry changes, National Chimney adapts to fulfill our customers' needs. Premier Flex Lite Liner has the same quality and technology as our standard Premier Flex Liner except it is much lighter. It is constructed of .010" thick steel as opposed to the standard heavy wall .015" thick steel. Each Premier Lite Kit comes with instructions and a lifetime warranty.

Premier Lite

Standard Liner Kit



PRL KIT 304		PRL KIT 316	
PRL515KIT	\$403.11	PRL515KITL	\$443.56
PRL520KIT	\$482.37	PRL520KITL	\$536.26
PRL525KIT	\$561.61	PRL525KITL	\$628.98
PRL530KIT	\$640.88	PRL530KITL	\$721.70
PRL535KIT	\$720.11	PRL535KITL	\$814.42
PRL550KIT	\$957.87	PRL550KITL	\$1,092.61
PRL5.515KIT	\$433.96	PRL5.515KITL	\$477.27
PRL5.520KIT	\$518.86	PRL5.520KITL	\$576.59
PRL5.525KIT	\$603.77	PRL5.525KITL	\$675.94
PRL5.530KIT	\$688.68	PRL5.530KITL	\$775.28
PRL5.535KIT	\$773.59	PRL5.535KITL	\$874.64
PRL5.550KIT	\$1,028.31	PRL5.550KITL	\$1,172.66
PRL615KIT	\$433.96	PRL615KITL	\$477.27
PRL620KIT	\$518.86	PRL620KITL	\$576.59
PRL625KIT	\$603.77	PRL625KITL	\$675.94
PRL630KIT	\$688.68	PRL630KITL	\$775.28
PRL635KIT	\$773.59	PRL635KITL	\$874.64
PRL650KIT	\$1,028.31	PRL650KITL	\$1,172.66
PRL720KIT	\$633.95	PRL720KITL	\$708.38
PRL725KIT	\$743.41	PRL725KITL	\$836.44
PRL730KIT	\$852.83	PRL730KITL	\$964.47
PRL735KIT	\$962.31	PRL735KITL	\$1,092.52
PRL750KIT	\$1,290.60	PRL750KITL	\$1,476.65
PRL815KIT	\$601.66	PRL815KITL	\$667.83
PRL820KIT	\$731.43	PRL820KITL	\$819.66
PRL825KIT	\$861.19	PRL825KITL	\$971.49
PRL830KIT	\$990.96	PRL830KITL	\$1,123.29
PRL835KIT	\$1,120.71	PRL835KITL	\$1,275.10
PRL850KIT	\$1,509.96	PRL850KITL	\$1,730.58

Premier Lite

Basic Liner Kit



PRL BK 304		PRL BK 316	
PRL515BK	\$330.25	PRL515BKL	\$370.69
PRL520BK	\$409.52	PRL520BKL	\$463.41
PRL525BK	\$488.76	PRL525BKL	\$556.13
PRL530BK	\$568.02	PRL530BKL	\$648.84
PRL535BK	\$647.25	PRL535BKL	\$741.57
PRL550BK	\$885.02	PRL550BKL	\$1,019.75
PRL5.515BK	\$335.76	PRL5.515BKL	\$379.06
PRL5.520BK	\$420.64	PRL5.520BKL	\$478.38
PRL5.525BK	\$505.56	PRL5.525BKL	\$577.72
PRL5.530BK	\$590.46	PRL5.530BKL	\$677.06
PRL5.535BK	\$675.38	PRL5.535BKL	\$776.43
PRL5.550BK	\$930.10	PRL5.550BKL	\$1,074.45
PRL615BK	\$355.97	PRL615BKL	\$399.27
PRL620BK	\$440.85	PRL620BKL	\$498.58
PRL625BK	\$525.76	PRL625BKL	\$597.94
PRL630BK	\$610.68	PRL630BKL	\$697.28
PRL635BK	\$695.58	PRL635BKL	\$796.64
PRL650BK	\$950.31	PRL650BKL	\$1,094.66
PRL720BK	\$548.37	PRL720BKL	\$622.79
PRL725BK	\$657.83	PRL725BKL	\$750.85
PRL730BK	\$767.24	PRL730BKL	\$878.89
PRL735BK	\$876.73	PRL735BKL	\$1,006.94
PRL750BK	\$1,205.02	PRL750BKL	\$1,391.07
PRL815BK	\$509.47	PRL815BKL	\$575.65
PRL820BK	\$639.25	PRL820BKL	\$727.48
PRL825BK	\$769.01	PRL825BKL	\$879.31
PRL830BK	\$898.77	PRL830BKL	\$1,031.10
PRL835BK	\$1,028.53	PRL835BKL	\$1,182.92
PRL850BK	\$1,417.77	PRL850BKL	\$1,638.40

Premier Flex Lite

316 (PRL) & 304 (PR) Liners



As the chimney industry changes, National Chimney adapts to fulfill our customers' needs. Premier Flex Lite Liner has the same quality and technology as our standard Premier Flex Liner except it is much lighter. It is constructed of .010" thick steel as opposed to the standard heavy wall .015" thick steel. The thinner steel has the durability of the heavy wall liner but at a more manageable weight. Offered in 304 and 316 L/Ti. See our M-Flex Smoothwall Chimney Liner, if you need a liner that reduces sizing by 20%.

	3"	4"	5"	5.5"	6"	7"	8"	9"	10"	11"	12"
5'	PRL35 \$68.74	PRL45 \$82.50	PRL55L \$97.60 PRL55 \$83.40	PRL5.55L \$104.58 PRL5.55 \$89.39	PRL65L \$104.58 PRL65 \$89.39	PRL75 \$115.20	PRL85L \$159.80 PRL85 \$136.58	PRL95 \$174.14	PRL105 \$183.35	PRL115 \$210.82	PRL125 \$238.35
10'	PRL310 \$137.52	PRL410 \$164.98	PRL510L \$195.19 PRL510 \$166.83	PRL5.510L \$209.17 PRL5.510 \$178.74	PRL610 \$178.74	PRL710 \$230.40	PRL810L \$319.64 PRL810 \$273.19	PRL910 \$348.33	PRL1010L \$429.01 PRL1010 \$366.69	PRL1110L \$493.38 PRL1110 \$421.70	PRL1210 \$476.68
15'	PRL315 \$206.25	PRL415 \$247.51	PRL515L \$292.81 PRL515 \$250.24	PRL5.515L \$313.74 PRL5.515 \$268.16	PRL615L \$313.74 PRL615 \$268.16	PRL715 \$345.59	PRL815L \$479.42 PRL815 \$409.75	PRL915L \$611.37 PRL915 \$522.52	PRL1015L \$643.53 PRL1015 \$550.02	PRL1115L \$740.04 PRL1115 \$632.52	PRL1215 \$715.03
20'	PRL320L \$321.76 PRL320 \$275.01	PRL420L \$386.09 PRL420 \$330.02	PRL520L \$390.41 PRL520 \$333.68	PRL5.520L \$418.29 PRL5.520 \$357.52	PRL620L \$418.29 PRL620 \$357.52	PRL720L \$539.12 PRL720 \$460.78	PRL820L \$639.23 PRL820 \$546.37	PRL920L \$815.13 PRL920 \$696.70	PRL1020L \$858.04 PRL1020 \$733.35	PRL1120L \$900.92 PRL1120 \$843.37	PRL1220 \$953.39
25'	PRL325 \$343.77	PRL425L \$482.64 PRL425 \$412.53	PRL525L \$488.00 PRL525 \$417.09	PRL5.525L \$522.87 PRL5.525 \$446.90	PRL625L \$522.87 PRL625 \$446.90	PRL725L \$673.92 PRL725 \$575.99	PRL825L \$799.06 PRL825 \$682.95	PRL925L \$1,018.91 PRL925 \$870.86	PRL1025L \$1,072.54 PRL1025 \$916.70	PRL1125L \$1,233.41 PRL1125 \$1,054.21	PRL1225L \$1,394.30 PRL1225 \$1,394.30
30'	PRL330 \$412.53	PRL430L \$579.17 PRL430 \$495.02	PRL530L \$585.60 PRL530 \$500.52	PRL5.530L \$627.44 PRL5.530 \$536.28	PRL630L \$627.44 PRL630 \$536.28	PRL730L \$808.70 PRL730 \$691.17	PRL830L \$958.84 PRL830 \$819.55	PRL930L \$1,222.71 PRL930 \$1,045.06	PRL1030L \$1,287.04 PRL1030 \$1,100.04	PRL1130L \$1,480.11 PRL1130 \$1,265.05	
35'	PRL335 \$481.26	PRL435L \$675.71 PRL435 \$577.53	PRL535L \$683.20 PRL535 \$583.92	PRL5.535L \$732.03 PRL5.535 \$625.65	PRL635L \$732.03 PRL635 \$625.65	PRL735L \$943.48 PRL735 \$806.42	PRL835L \$1,118.64 PRL835 \$956.13	PRL935L \$1,426.46 PRL935 \$1,219.21	PRL1035L \$1,501.55 PRL1035 \$1,283.37	PRL1135 \$1,475.88	PRL1235L \$1,952.02 PRL1235 \$1,668.41
50'	PRL350 \$687.54	PRL450L \$965.28 PRL450 \$825.02	PRL550L \$976.03 PRL550 \$834.20	PRL5.550L \$1,045.73 PRL5.550 \$893.78	PRL650L \$1,045.73 PRL650 \$893.78	PRL750L \$1,347.83 PRL750 \$1,151.99	PRL850L \$1,598.10 PRL850 \$1,365.86	PRL950L \$2,037.84 PRL950 \$1,741.73	PRL1050L \$2,145.09 PRL1050 \$1,833.40	PRL1150L \$2,466.84 PRL1150 \$2,108.40	

	13"		14"		16"	
Per Foot	PRL13 \$53.15	PRL13L \$62.50	PRL14 \$59.56	PRL14L \$69.21	PRL16 \$66.40	PRL16L \$74.25

Premier Winch

The Premier Winch measures 15" x 15" at the base to fit even the smallest chimney. It has a capacity of 1,000 lbs, yet weighs only 28.5 lbs. Comes with 50 ft of 7/32" cable. One leg adjusts for a rock free set on any surface.

PREMIER WINCH
WINCH: \$630.15



M-Flex Premier

Premier Flex Lite

Rectangle Liner

FOR WOOD & WOOD PELLET APPLICATIONS



	5.75" x 9.5"	6" x 10"	7" x 11"	8" x 12"
5'	PRL57595REC5 \$179.53	PRL610REC5 \$217.31	PRL711REC5 \$226.48	PRL812REC5 \$253.98
10'	PRL57595REC10 \$359.45	PRL610REC10 \$434.61	PRL711REC10 \$452.95	PRL812REC10 \$507.96
15'	PRL57595REC15 \$539.17	PRL610REC15 \$651.92	PRL711REC15 \$679.42	PRL812REC15 \$761.94
20'	PRL57595REC20 \$718.90	PRL610REC20 \$869.24	PRL711REC20 \$905.91	PRL812REC20 \$1,015.91
25'	PRL57595REC25 \$898.63	PRL610REC25 \$1,086.54	PRL711REC25 \$1,132.38	PRL812REC25 \$1,269.90
30'	PRL57595REC30 \$1,078.34	PRL610REC30 \$1,303.85	PRL711REC30 \$1,358.86	PRL812REC30 \$1,437.57
35'	PRL57595REC35 \$1,258.07	PRL610REC35 \$1,521.14	PRL711REC35 \$1,585.33	PRL812REC35 \$1,777.84
50'	PRL57595REC50 \$1,797.22	PRL610REC50 \$2,173.07	PRL711REC50 \$2,264.74	PRL812REC50 \$2,539.75

Premier Flex Lite

Square Liner

FOR WOOD & WOOD PELLET APPLICATIONS



	5'	10'	15'	20'	25'	30'	35'	50'
10" x 10"	PRL1010SQ5 \$253.98	PRL1010SQ10 \$507.96	PRL1010SQ15 \$761.94	PRL1010SQ20 \$1,015.91	PRL1010SQ25 \$1,269.90	PRL1010SQ30 \$1,437.57	PRL1010SQ35 \$1,777.84	PRL1010SQ50 \$2,539.75
11" x 11"	PRL1111SQ5 \$281.48	PRL1111SQ10 \$562.96	PRL1111SQ15 \$844.44	PRL1111SQ20 \$1,082.78	PRL1111SQ25 \$1,407.38	PRL1111SQ30 \$1,688.87	PRL1111SQ35 \$1,970.34	PRL1111SQ50 \$2,814.77

Premier Flex

Rectangle Liner

FOR WOOD & WOOD PELLET APPLICATIONS



	5.75" x 9.5"	6" x 10"	7" x 11"	8" x 12"
5'	NCPR57595REC5 \$245.52	NCPR610REC5 \$251.09	NCPR711REC5 \$317.17	NCPR812REC5 \$338.92
10'	NCPR57595REC10 \$491.05	NCPR610REC10 \$502.20	NCPR711REC10 \$634.33	NCPR812REC10 \$677.83
15'	NCPR57595REC15 \$736.55	NCPR610REC15 \$753.28	NCPR711REC15 \$951.51	NCPR812REC15 \$1,016.78
20'	NCPR57595REC20 \$982.06	NCPR610REC20 \$1,004.38	NCPR711REC20 \$1,268.65	NCPR812REC20 \$1,355.71
25'	NCPR57595REC25 \$1,227.59	NCPR610REC25 \$1,255.49	NCPR711REC25 \$1,585.82	NCPR812REC25 \$1,694.62
30'	NCPR57595REC30 \$1,473.11	NCPR610REC30 \$1,506.57	NCPR711REC30 \$1,902.98	NCPR812REC30 \$2,033.53
35'	NCPR57595REC35 \$1,718.62	NCPR610REC35 \$1,757.67	NCPR711REC35 \$2,220.15	NCPR812REC35 \$2,372.46
50'	NCPR57595REC50 \$2,455.15	NCPR610REC50 \$2,510.95	NCPR711REC50 \$3,171.62	NCPR812REC50 \$3,389.24

Premier Flex

Square Liner

FOR WOOD & WOOD PELLET APPLICATIONS

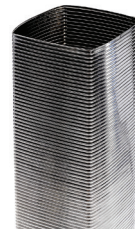

*All fuel Premier Flex Rectangle Liner (316) is available. Please call customer service for pricing.

	10" x 10"	11" x 11"		10" x 10"	11" x 11"
5'	NCPR1010SQ5 \$338.92	NCPR1111SQ5 \$360.68	25'	NCPR1010SQ25 \$1,694.62	NCPR1111SQ25 \$1,803.44
10'	NCPR1010SQ10 \$677.83	NCPR1111SQ10 \$721.38	30'	NCPR1010SQ30 \$2,033.53	NCPR1111SQ30 \$2,164.11
15'	NCPR1010SQ15 \$1,016.78	NCPR1111SQ15 \$1,082.07	35'	NCPR1010SQ35 \$2,372.46	NCPR1111SQ35 \$2,524.77
20'	NCPR1010SQ20 \$1,355.71	NCPR1111SQ20 \$1,442.76	50'	NCPR1010SQ50 \$3,389.24	NCPR1111SQ50 \$3,606.85

M-Flex Aluminum Liner

M-FLEX ALUMINUM LINER & KITS

National Chimney manufactures our M-FLEX aluminum liner kits for appliances with A.F.U.E. of 83% or lower.



Each aluminum kit comes professionally packed and includes:

- UL Listed and Tested 2-ply aluminum liner
- Aluminum mortar collar for slipping the liner through the thimble
- Aluminum top plate with a 16" x 16" plate and a 2" high collar around the hole diameter
- Aluminum cap, and installation instructions

All M-FLEX aluminum liner kits come with a 25-Year Warranty and are listed to UL441.

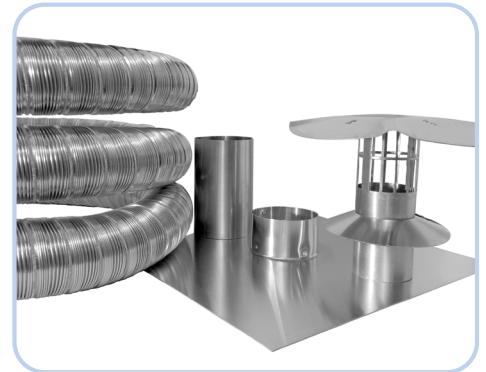

Kits

	3"	4"	5"	5.5"	6"	7"	8"
10' Extension	DB310EXT \$35.72	DB410EXT \$42.86	DB510EXT \$55.25	DB5.510EXT \$59.46	DB610EXT \$62.57	DB710EXT \$69.65	DB810EXT \$79.15
25'	DB325KIT \$91.09	DB425KIT \$97.03	DB525KIT \$142.36	DB5.525KIT \$154.76	DB625KIT \$167.17	DB725KIT \$202.76	DB825KIT \$231.48
30'	DB330KIT \$100.76	DB430KIT \$107.78	DB530KIT \$158.86	DB5.530KIT \$166.80	DB630KIT \$180.97	DB730KIT \$227.48	DB830KIT \$264.57
35'	DB335KIT \$111.91	DB435KIT \$118.48	DB535KIT \$175.37	DB5.535KIT \$185.08	DB635KIT \$194.76	DB735KIT \$252.43	DB835KIT \$293.51
50'	DB350KIT \$142.69	DB450KIT \$174.19	DB550KIT \$215.49	DB5.550KIT \$236.14	DB650KIT \$256.79	DB750KIT \$327.21	DB850KIT \$382.40

Aluminum

Linear Extension



DB210EXT	\$32.20
DB310EXT	\$35.72
DB410EXT	\$42.86
DB510EXT	\$55.25
DB610EXT	\$62.57
DB710EXT	\$69.65
DB810EXT	\$79.15

Aluminum Direct Vent Kit



The Aluminum Direct Vent Kit is designed to vent any direct vent/Co-Linear gas-fueled appliance. This kit includes your choice of a low profile Co-Linear cap and flashing or a high wind Co-Linear cap with flashing and either two 3" diameter aluminum chimney liners or one 3" and one 4" diameter aluminum chimney liner. Also included are EZ clamps for attaching the liner. These kits come with a 25-Year Warranty.

Aluminum 3003 Liner



National Chimney's 2-Ply 3003 aluminum liner can be used to vent Category I gas appliances with A.F.U.E. of 83% or lower. In many cases, especially when only water heaters are vented into masonry flues, the gas appliances are vented into oversized flues. This practice may cause serious condensation and performance problems. By relining the chimney with National Chimney M-FLEX aluminum liner you can reduce the condensation problem and improve the performance of the appliances.



	2"	3"	4"	5"	5.5"	6"	7"	8"
25'	DB225 \$49.29	DB325 \$54.26	DB425 \$72.35	DB525 \$90.42	DB5.525 \$103.38	DB625 \$108.53	DB725 \$126.60	DB825 \$144.68
30'	DB230 \$60.20	DB330 \$65.12	DB430 \$86.80	DB530 \$108.53	DB5.530 \$124.02	DB630 \$130.21	DB730 \$151.94	DB830 \$173.63
35'	DB235 \$70.84	DB335 \$75.97	DB435 \$101.29	DB535 \$126.60	DB5.535 \$144.68	DB635 \$152.08	DB735 \$177.26	DB835 \$202.56
50'	DB250 \$103.90	DB350 \$108.53	DB450 \$144.68	DB550 \$180.85	DB5.550 \$206.71	DB650 \$217.06	DB750 \$253.23	DB850 \$289.37

Aluminum Components



	3"	4"	5"	5.5"	6"	7"	8"
Coupler ID (male/male)	NC3CAL \$8.96	NC4CAL \$9.55	NC5CAL \$10.74	NC5.5CAL \$11.35	NC6CAL \$11.35	NC7CAL \$11.93	NC8CAL \$12.52
Top Plate	NC3TPAL1616 \$25.07	NC4TPAL1616 \$25.07	NC5TPAL1616 \$25.07	NC5.5TPAL1616 \$25.07	NC6TPAL1616 \$25.07	NC7TPAL1616 \$25.07	NC8TPAL1616 \$25.07
Mortar Collar	NC3MCAL \$15.09	NC4MCAL \$15.60	NC5MCAL \$17.26	NC5.5MCAL \$18.33	NC6MCAL \$18.33	NC7MCAL \$19.41	NC8MCAL \$21.02
Rain Cap	3MCU \$28.54	4MCU \$30.03	5MCU \$38.35	MF5MCU \$34.97	6MCU \$51.25	7MCU \$82.33	8MCU \$101.65



Coupler



Top Plate



Mortar Collar



Rain Cap

M-Flex Co-Linear Kits

Aluminum

Low Profile Co-Linear Kit



Low Profile Co-Linear Caps and Kits—A sleek and unique cap with an installed height of just 7". Our Low Profile Co-Linear Cap is manufactured using the highest quality commercial grade aluminum. This cap comes with a 3" air intake and has the option of a 3" or 4" exhaust. EZ connect bands connect the liner to each collar, eliminating the need for screws and rivets. Each Low Profile Cap comes with a standard 13" x 13" flashing. (an 18" x 18" flashing is also available.)



Transferable Lifetime Warranty for Stainless Steel; 25-Year Warranty for aluminum.

Intake 3" / Exhaust 3"		
LOW PROFILE KIT 25'	33DVSSBC25	\$421.90
LOW PROFILE KIT 35'	33DVSSBC35	\$508.11
Intake 3" / Exhaust 4"		
LOW PROFILE KIT 25'	34DVSSBC25	\$429.79
LOW PROFILE KIT 35'	34DVSSBC35	\$515.38

Caps



Intake 3" / Exhaust 3"		
13X13	33SBCAL1313	\$100.96
18X18	33SBCAL1818	\$113.76
Intake 3" / Exhaust 4"		
13X13	34SBCAL1313	\$100.96
18X18	34SBCAL1818	\$113.76

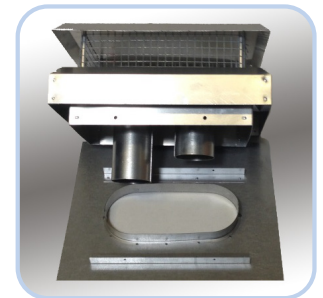

Stainless Steel



High Wind Co-Linear Caps

Intake 3" / Exhaust 3"		
Co-Linear CAP 13.5	33RFC13.5	\$198.01
Co-Linear CAP 15.5	33RFC15.5	\$211.46
Co-Linear CAP 18.5	33RFC18.5	\$224.29



Aluminum

High Wind Co-Linear Kit

Intake 3" / Exhaust 3"		
HIGH WIND KIT 25'	33DVARFC25	\$279.17
HIGH WIND KIT 35'	33DVARFC35	\$300.90

- Includes Stainless Steel Termination
- Commercial Grade Aluminum
- EZ connect bands
- Warranty for Aluminum



Stainless Steel

Direct Vent Kits



The Stainless Steel Direct Vent Kit is a great option for upgrading your gas-fueled co-linear appliance. They can be used with Wood Pellet inserts that require an air intake. This kit includes your choice of a Stainless Steel low profile cap and flashing or a Stainless Steel high wind co-linear cap and flashing. You also have a choice of one 3" Aluminum air intake liner and one 3" Stainless Steel exhaust liner or one 3" Aluminum air intake liner and one 4" Stainless Steel exhaust liner. Included are EZ clamps to connect the liners to the cap. These kits offer a Lifetime Warranty for Residential use on all Stainless Steel parts (25-Year Warranty for Commercial use). The Aluminum air intake liner has a 25-Year Warranty.

Stainless Steel

Low Profile Co-Linear Kits

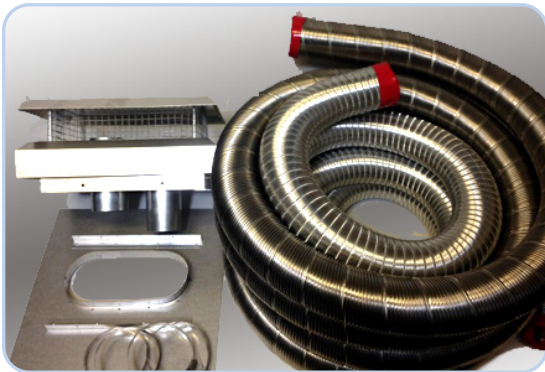

Intake 3" / Exhaust 3"		
LOW PROFILE KIT 25'	33DVASBC25	\$279.17
LOW PROFILE KIT 35'	33DVASBC35	\$300.90
Intake 3" / Exhaust 4"		
LOW PROFILE KIT 25'	34DVASBC25	\$289.21
LOW PROFILE KIT 35'	34DVASBC35	\$313.21

Stainless Steel

High Wind Co-Linear Kits



High Wind Co-Linear Caps and Kits—A great option for applications where wind is a challenge for venting systems. Our High Wind Co-Linear Cap is manufactured using the highest quality mill certified 24ga 304 stainless steel. The cap comes with a 3" air intake and has the option of a 3" or 4" exhaust. EZ connect bands connect the liner to each collar, eliminating the need for screws and rivets. Each High Wind Cap comes with a standard 13" x 13" flashing. Additional flashings for Factory Chimneys are available. Transferable Lifetime Warranty.



Intake 3" / Exhaust 3"		
HIGH WIND KIT 25'	33DVSRFC25	\$421.90
HIGH WIND KIT 35'	33DVSRFC35	\$508.11
Intake 3" / Exhaust 4"		
HIGH WIND KIT 25'	34DVSRFC25	\$429.79
HIGH WIND KIT 35'	34DVSRFC35	\$515.38

M-Flex Stainless Steel Liner

Stainless Steel Premier Rigid Lining System

The Premier Rigid Lining System is constructed of high grade, 24ga stainless steel. Available in 316 alloy (SSL) for all fuel applications and 304 alloy (SS) for wood burning applications. To ensure the tee fits properly use an "OD" tee. Rigid liner systems also require the use of a standard top plate, top clamp, storm collar and liner rain cap.

UL Listed up to 40" Diameter. Call for pricing on 13" - 40".



	3"	4"	5"	6"	7"	8"	9"	10"	11"	12"
12" Length 316	NC312SSL \$29.17	NC412SSL \$29.84	NC512SSL \$30.45	NC612SSL \$35.02	NC712SSL \$35.54	NC812SSL \$40.95	Custom	Custom	Custom	Custom
12" Length 304	NC312SS \$19.94	NC412SS \$20.44	NC512SS \$21.12	NC612SS \$22.73	NC712SS \$25.90	NC812SS \$27.99	NC912SS \$30.69	NC1012SS \$39.16	NC1112SS \$45.06	NC1212SS \$50.54
18" Length 316	NC318SSL \$33.06	NC418SSL \$42.61	NC518SSL \$38.91	NC618SSL \$54.47	NC718SSL \$66.12	NC818SSL \$68.09	Custom	Custom	Custom	Custom
18" Length 304	NC318SS \$23.16	NC418SS \$33.06	NC518SS \$32.80	NC618SS \$36.00	NC718SS \$38.91	NC818SS \$39.77	NC918SS \$43.06	NC1018SS \$52.55	NC1118SS \$62.97	NC1218SS \$74.10
24" Length 316	NC324SSL \$35.02	NC424SSL \$48.61	NC524SSL \$62.26	NC624SSL \$68.09	NC724SSL \$75.86	NC824SSL \$83.68	Custom	Custom	Custom	Custom
24" Length 304	NC324SS \$25.39	NC424SS \$43.00	NC524SS \$38.91	NC624SS \$40.87	NC724SS \$44.75	NC824SS \$51.56	NC924SS \$53.69	NC1024SS \$87.53	NC1124SS \$88.91	NC1224SS \$94.50
36" Length 316	NC336SSL \$62.17	NC436SSL \$75.50	NC536SSL \$89.50	NC636SSL \$92.20	NC736SSL \$116.73	NC836SSL \$124.48	Custom	Custom	Custom	Custom
36" Length 304	NC336SS \$38.50	NC436SS \$54.47	NC536SS \$58.34	NC636SS \$56.41	NC736SS \$66.12	NC836SS \$74.43	NC936SS \$82.58	NC1036SS \$106.99	NC1136SS \$112.83	NC1236SS \$120.61
48" Length 316	Custom	NC448SSL \$97.27	NC548SSL \$106.99	NC648SSL \$117.89	NC748SSL \$142.00	NC848SSL \$169.46	Custom	Custom	Custom	Custom
48" Length 304	Custom	NC448SS \$66.74	NC548SS \$77.83	NC648SS \$71.97	NC748SS \$87.53	NC848SS \$97.27	NC948SS \$111.89	NC1048SS \$126.44	NC1148SS \$138.94	NC1248SS \$148.22

Ovalizer

NEED AN OVALIZED SIZE?

You can ovalize it yourself at the job site with your own Ovalizer.

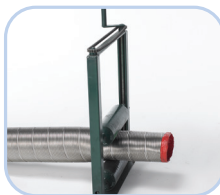

OVALIZER
\$1,238.49



OR, WE CAN DO IT FOR YOU...

OVALIZELW:	\$2.26 PER FOOT
OVALIZEHW:	\$3.00 PER FOOT

WHY CUSTOMERS LOVE NATIONAL CHIMNEY

“

As someone who has been in the industry over the last 25 years, I can honestly say that **National Chimney Supply has been a true PARTNER throughout the years.** They have always been an effective and reliable provider of materials and tools. I have no issue with flat out saying they are the best! **But in addition to that, and what has kept our relationship so good over the years, has been their leadership and support in our industry's education and training.** To me, the business relationship that has been built since 1998 (when I got into the chimney business) is immeasurable as far as its value.

- Ryan Hall, *Winstons Chimney*

The Dimensions of an Ovalized Liner

READING THE CHART

- 1 Find the original round liner diameter in the first column
- 2 Select the smaller oval side you need along the top of the chart
- 3 Follow the row across and column down to find the large side dimension

EXAMPLE

6" Liner Ovalized Down to 5" = 5" X 7.4"

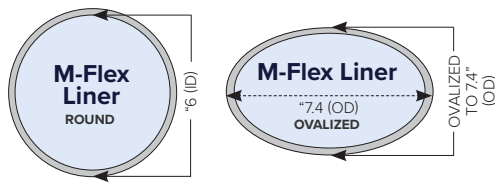

	4"	5"	6"	7"	8"	9"	10"	11"
12"								
11"								
10"								
9"								
8"								
7"								
6"								

SIZING FOR FIREPLACES

- 1 Measure fireplace opening Width x Height
- 2 Divide by 12
- 3 Select a liner with equal or larger square inches

EXAMPLE

$$36" \times 28" = 1008$$

$$1008 \div 12 = 84 \text{ in}^2$$

Select liner with area $\geq 84 \text{ in}^2$

Premier Flex Heavywall

Custom Rectangle or Square Sizing Chart

Unusual sized chimneys need unusual sized liners. National Chimney Custom Sheet Metal Shop will fabricate any liner on this chart with custom fit components to match. Made from .015 Stainless Steel. While determining what custom flex you need, please note the TWO different types available:

PR (304): wood and wood pellet applications

PRL (316): all fuel applications

READING THE CHART

- 1 Locate the small side dimension of the rectangle on the left side of the chart.
- 2 Follow that row across until you find the desired large side dimension.
- 3 From that column, move down to the bottom of the chart to find the price per foot for the liner material.
- 4 Multiply the price per foot by the total liner length needed to calculate the total price.

EXAMPLE

8.5" x 9.5" rectangle liner costs:

\$50.88 per foot **\$73.94 per foot**
 304 Stainless Steel 316 Stainless Steel

LARGE SIDE

Original Liner Diameter

SMALL SIDE

	6	7	8	9	10	11	12	13	14	16	18
4.5	6	8	10	11.5	13.5	15	17	19			
5	5.5	7.5	9.5	11	13	14.5	16.5	18.5	20	23.5	
5.5		7	9	10.5	12.5	14	16	18	19.5	23	
6		6.5	8.5	10	12	13.5	16.5	17.5	19	22.5	
6.5			8	9.5	11.5	13	15	17	18.5	22	
7			7.5	9	11	12.5	14.5	16.5	18	21.5	
7.5				8.5	10.5	12	14	16	17.5	21	
8				8	10	11.5	13.5	16.5	17	20.5	24
8.5					9.5	11	13	15	16.5	20	23.5
9					9	10.5	12.5	14.5	16	19.5	23
9.5						10	12	14	16.5	19	22.5
10						9.5	11.5	13.5	15	18.5	22
10.5							11	13	14.5	18	21.5
11								12.5	14	17.5	21
11.5								12	13.5	17	20.5
12									13	16.5	20
12.5									12.5	16	19.5
13										16.5	19
13.5										15	18.5
14											18
14.5											17.5
15											17
15.5											16.5
16											16
PR304	\$30.52	\$35.61	\$40.71	\$45.79	\$50.88	\$55.98	\$61.05	\$66.14	\$71.23	\$81.40	\$91.58
PR316L	\$44.36	\$51.75	\$59.16	\$66.55	\$73.94	\$81.33	\$88.73	\$96.12	\$103.52	\$118.29	\$133.08

Price Per Foot

CHIMNEY COMPONENTS



Round Stainless Steel Components

National Chimney components are made from high quality 24ga 316 (L) or 24ga 304 steel. Couplers are fabricated without clamps (standard) or with clamps on both the female and male ends (EZ). Bottom plates come standard with 18ga 304 stainless base plate and a 5" high 24ga collar. National Chimney nose cones are designed to fit over the liner. National Chimney has a full custom shop for complex applications.



Couplers & Adapters



**COUPLER
(MALE/FEMALE)**



**COUPLER
(MALE/MALE)**



FITS OVER APPLIANCE OUTLET

**APPLIANCE
ADAPTER**

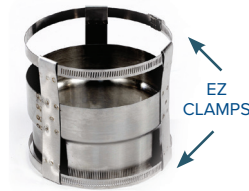

**EZ COUPLER
(MALE/FEMALE)**



**INSIDE MOUNT
STOVE ADAPTER**

Bottom Plates

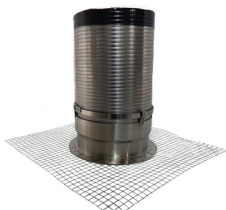

**ROUND COUPLER
STYLE MESH
BOTTOM PLATE**

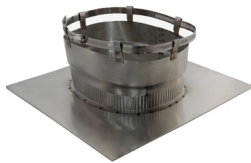

**RECTANGLE
COUPLER STYLE
BOTTOM PLATE**

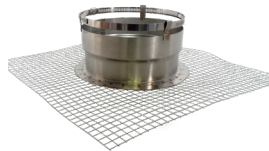

**RECTANGLE COUPLER
STYLE MESH
BOTTOM PLATE**

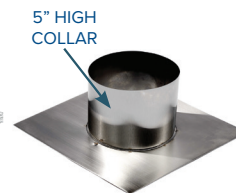

5" HIGH
COLLAR

**BOTTOM
PLATE**

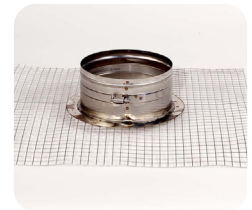

**MESH
BOTTOM PLATE**

Caps



**F LINER RAIN CAP
WITH DIVERTER
CONE**



**TOP KIT WITH
DIVERTER CONE**



**ROUND LID
LINER RAIN CAP**



**LINER RAIN CAP
WITH DIVERTER**



**CO-LINEAR CAP
FLUE FIT**

Nose Cones & Storm Collars

NOSE CONE



STORM COLLAR



WHY CUSTOMERS LOVE NATIONAL CHIMNEY

“

I would like to take a few minutes to discuss my experience and relationship with Michael and the entire National Chimney Supply team. We have been in business in Baltimore for nearly 40 years and have been exclusively purchasing supplies from National for the last 10 years. **The customer service is outstanding and is an excellent resource for ordering and any general questions.**

Deliveries are prompt and Bryce does an outstanding job getting out ordered items into our warehouse. Michael has delivered emergency request for materials in his personal vehicle that day to our shop. My previous supply partners would not even have considered this. **Mike has been a great sounding board and source for professional advice over the years and has helped our business grow.**

- Cullen Davis, *Clean Sweep Chimney, Gutter & Slate Service*

Round Stainless Steel Components

	3"	4"	5"	5.5"	
Appliance Adapter 316	NC3AA \$22.46	NC4AA \$26.74	NC5AA \$28.87	NC5.5AA \$31.04	
Bottom Plate 304 13" x 13"	Custom	Custom	NC5BP \$38.40	Custom	
13" x 18"	Custom	Custom	Custom	Custom	
18" x 18"	Custom	Custom	Custom	Custom	
EZ Coupler ID 316	NC3CEZL \$22.46	NC4CEZL \$26.74	NC5CEZL \$28.87	NC5.5CEZL \$31.04	
EZ Coupler ID 304	NC3CEZ \$19.41	NC4CEZ \$19.99	NC5CEZ \$20.85	NC5.5CEZ \$21.27	
EZ Coupler OD 316	Custom	Custom	Custom	Custom	
Coupler ID 316	NC3CL \$18.17	NC4CL \$19.27	NC5CL \$20.30	NC5.5CL \$22.46	
Coupler ID 304	NC3C \$14.33	NC4C \$14.77	NC5C \$15.31	NC5.5C \$16.43	
Coupler OD 316	Custom	Custom	Custom	Custom	
Coupler OD 304	Custom	Custom	Custom	Custom	
Inside Mount Stove Adapter	NC3SAI \$34.13	NC4SAI \$34.53	NC5SAI \$35.04	NC5.5SAI \$37.02	
Male/Male Coupler ID 316	NC3MMCL \$18.17	NC4MMCL \$19.27	NC5MMCL \$20.30	NC5.5MMCL \$22.46	
Nose Cone ID 304	NC3NC \$40.87	NC4NC \$42.90	NC5NC \$44.97	NC5.5NC \$46.98	
Nose Cone OD 304	Custom	Custom	NC5NCOD \$42.80	Custom	
Rain Cap 304	NC3RC \$39.89	NC4RC \$39.89	NC5RC \$45.20	NC5.5RC \$48.40	
Round Rain Cap	NC3RCR \$47.76	NC4RCR \$47.76	NC5RCR \$52.78	NC5.5RCR \$52.78	
Storm Collar 304	NC3SC \$20.18	NC4SC \$20.67	NC5SC \$21.58	NC5.5SC \$22.47	
Bottom Plate Mesh Coupler Style	Custom	Custom	Custom	Custom	
Bottom Plate Coupler Style 13" x 13"	Custom	Custom	NC5BPC \$75.69	Custom	
13" x 18"	Custom	Custom		Custom	
18" x 18"	Custom	Custom		Custom	

CHIMNEY COMPONENTS

	6"	7"	8"	9"	10"	11"	12"
	NC6AA \$31.04	NC7AA \$35.40	NC8AA \$39.58	Custom	Custom	Custom	Custom
	NC6BP \$40.31	NC7BP \$40.31	NC8BP \$40.31	NC9BP \$40.31	NC10BP \$40.31	NC11BP \$40.31	Custom
	NC6BP1318 \$50.82	NC7BP1318 \$50.82	NC8BP1318 \$50.82	NC9BP1318 \$50.82	NC10BP1318 \$50.82	NC11BP1318 \$50.82	Custom
	NC6BP1818 \$62.25	NC7BP1818 \$62.25	NC8BP1818 \$62.25	NC9BP1818 \$62.25	NC10BP1818 \$62.25	NC11BP1818 \$62.25	NC12BP1818 \$62.25
	NC6CEZL \$31.04	NC7CEZL \$35.40	NC8CEZL \$39.78	NC9CEZL \$42.78	NC10CEZL \$47.04	NC11CEZL \$52.47	NC12CEZL \$57.88
	NC6CEZ \$21.27	NC7CEZ \$25.16	NC8CEZ \$28.68	NC9CEZ \$35.11	NC10CEZ \$39.36	NC11CEZ \$46.00	NC12CEZ \$49.23
	NC6CODEZL \$31.04	NC7CODEZL \$35.40	NC8CODEZL \$39.78	Custom	Custom	Custom	Custom
	NC6CL \$22.46	NC7CL \$24.10	NC8CL \$25.68	NC9CL \$32.10	NC10CL \$36.38	NC11CL \$39.58	NC12CL \$41.70
	NC6C \$17.54	NC7C \$18.63	NC8C \$19.06	NC9C \$25.45	NC10C \$28.26	NC11C \$31.88	NC12C \$35.23
	NC6CODL \$22.46	NC7CODL \$24.10	NC8CODL \$25.68	Custom	Custom	Custom	Custom
	NC6COD \$17.54	NC7COD \$18.63	NC8COD \$19.06	Custom	Custom	Custom	Custom
	NC6SAI \$37.02	NC7SAI \$40.92	NC8SAI \$44.44	Custom	Custom	Custom	Custom
	NC6MMCL \$22.46	NC7MMCL \$24.10	NC8MMCL \$25.68	NC9MMCL \$32.10	NC10MMCL \$36.38	Custom	Custom
	NC6NC \$46.98	NC7NC \$49.01	NC8NC \$51.06	NC9NC \$53.13	NC10NC \$65.36	NC11NC \$69.45	NC12NC \$73.53
	NC6NCOD \$46.98	NC7NCOD \$49.01	NC8NCOD \$51.06	Custom	Custom	Custom	Custom
	NC6RC \$48.40	NC7RC \$53.61	NC8RC \$58.14	NC9RC \$62.65	NC10RC \$88.57	NC11RC \$107.41	NC12RC \$113.81
	NC6RCR \$55.95	NC7RCR \$61.03	NC8RCR \$65.40	Custom	Custom	Custom	Custom
	NC6SC \$22.47	NC7SC \$24.24	NC8SC \$26.62	NC9SC \$29.02	NC10SC \$41.47	NC11SC \$47.92	NC12SC \$48.92
	NC6BPCMESH1818 \$101.82	NC7BPCMESH1818 \$102.88	NC8BPCMESH1818 \$103.32	NC9BPCMESH1818 \$109.74	NC10BPCMESH1818 \$112.53	NC11BPCMESH1818 \$119.44	NC12BPCMESH1818 \$122.62
	NC6BPC \$79.91	NC7BPC \$80.99	NC8BPC \$81.42	NC9BPC \$87.84	NC10BPC \$90.62	Custom	Custom
	NC6BPC1318 \$90.42	NC7BPC1318 \$91.47	NC8BPC1318 \$91.90	NC9BPC1318 \$98.32	NC10BPC1318 \$101.10	Custom	Custom
	NC6BPC1818 \$101.82	NC7BPC1818 \$102.88	NC8BPC1818 \$103.32	NC9BPC1818 \$109.74	NC10BPC1818 \$112.53	Custom	Custom



Round Stainless Steel Components

	3"	4"	5"	5.5"	
Slip Connector 316 - Adjusts 3" to 12"	Custom	NC4SLIPL \$40.75	NC5SLIPL \$61.28	NC5.5SLIPL \$62.30	
Slip Connector 304	Custom	NC4SLIP \$32.87	NC5SLIP \$34.44	Custom	
Stove Adapter 304	NC3SA \$16.83	NC4SA \$17.24	NC5SA \$17.72	NC5.5BKC \$15.60	
Fixed Tee ID 316	NC3FXTL \$63.30	NC4FXTL \$65.36	NC5FXTL \$69.18	NC5.5FXTL \$75.69	
Fixed Tee ID 304	NC3FXT \$43.59	NC4FXT \$45.75	NC5FXT \$47.41	Custom	
Fixed Tee OD 316	NC3FXTODL \$63.30	NC4FXTODL \$65.36	NC5FXTODL \$69.18	Custom	
Fixed Tee OD 304	NC3FXTOD \$43.59	NC4FXTOD \$45.75	NC5FXTOD \$47.41	Custom	
Fixed Pellet Tee 304	NC3FXTP \$76.28	NC4FXTP \$87.53	Custom	Custom	
Short Body Pellet Tee	NC3FXTPSB \$72.61	NC4FXTPSB \$83.35	Custom	Custom	
2 Part Flex Tee ID 316	NC3FLEXL \$63.30	NC4FLEXL \$65.36	NC5FLEXL \$69.18	NC5.5FLEXL \$75.69	
2 Part Flex Tee ID 304	NC3FLEXT \$43.59	NC4FLEXT \$45.75	NC5FLEXT \$47.41	NC5.5FLEXT \$51.58	
2 Part Tee OD 316	NC3TEEL \$63.30	NC4TEEL \$65.36	NC5TEEL \$69.18	NC5.5TEEL \$75.69	
2 Part Tee OD 304	NC3TEE \$43.59	NC4TEE \$45.75	NC5TEE \$47.41	Custom	
Tee End Cap 316	NC3ECL \$21.20	NC4ECL \$21.80	NC5ECL \$25.24	NC5.5ECL \$27.69	
Tee End Cap 304	NC3EC \$13.60	NC4EC \$14.11	NC5EC \$14.23	NC5.5EC \$15.00	
Extended Tee Snout - 18" Long 316	Custom	NC4T18SL \$29.66	NC5T18SL \$49.56	6" Diameter Snout	
Extended Tee Snout - 18" Long 304	Custom	Custom	NC5T18S \$42.92	6" Diameter Snout	
Extended Tee Snout - 24" Long 316	Custom	Custom	NC5T24SL \$66.18	6" Diameter Snout	
Extended Tee Snout - 24" Long 304	Custom	Custom	NC5T24S \$59.56	6" Diameter Snout	



**STACKED
TEES**

When should I use an OD tee?

OD tees are used for stacking tees, putting two tees on top of each other. The OD tee is always used as the bottom tee. The top of the OD tee will accept the bottom of either an ID or OD tee. If an ID tee is used on the bottom, the two tees will be too loose due to the expansion of the top of the ID tee. OD tees are used when ordering a specific OD M-FLEX Liner.



When there is a liner between two tees, make sure both tees (2 ID tees) are the same (to accommodate the liner).

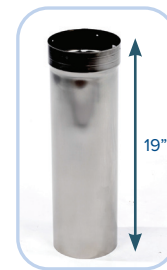

**SLIP
CONNECTOR**



**TEE
SNOOT**



CHIMNEY COMPONENTS

	6"	7"	8"	9"	10"	11"	12"
	NC6SLIPL \$62.31	NC7SLIPL \$71.50	NC8SLIPL \$80.71	Custom	Custom	Custom	Custom
	NC6SLIP \$37.23	NC7SLIP \$41.11	NC8SLIP \$46.32	NC9SLIP \$59.29	NC10SLIP \$64.84	NC11SLIP \$77.83	NC12SLIP \$88.91
	NC6SA \$21.27	NC7SA \$25.16	NC8SA \$28.68	Custom	Custom	Custom	Custom
	NC6FXTL \$75.69	NC7FXTL \$85.78	NC8FXTL \$93.81	NC9FXTL \$145.89	NC10FXTL \$165.35	NC11FXTL \$194.52	NC12FXTL \$213.98
	NC6FXT \$51.58	NC7FXT \$55.77	NC8FXT \$70.59	NC9FXT \$136.18	NC10FXT \$145.89	NC11FXT \$165.35	NC12FXT \$175.06
	NC6FXTODL \$75.69	NC7FXTODL \$85.82	NC8FXTODL \$93.83	Custom	Custom	Custom	Custom
	NC6FXTOD \$51.58	NC7FXTOD \$55.77	NC8FXTOD \$70.59	Custom	Custom	Custom	Custom
	Custom	Custom	Custom	Custom	Custom	Custom	Custom
	Custom	Custom	Custom	Custom	Custom	Custom	Custom
	NC6FLEXTL \$75.69	NC7FLEXTL \$85.78	NC8FLEXTL \$93.81	NC9FLEXTL \$145.89	NC10FLEXTL \$165.35	NC11FLEXTL \$194.52	NC12FLEXTL \$213.98
	NC6FLEXT \$51.58	NC7FLEXT \$55.77	NC8FLEXT \$70.59	NC9FLEXT \$136.18	NC10FLEXT \$145.89	NC11FLEXT \$165.35	NC12FLEXT \$175.06
	NC6TEEL \$75.69	NC7TEEL \$85.82	NC8TEEL \$93.83	NC9TEEL \$145.89	NC10TEEL \$165.35	NC11TEEL \$194.52	NC12TEEL \$213.98
	NC6TEE \$51.58	NC7TEE \$55.77	NC8TEE \$70.59	NC9TEE \$136.18	NC10TEE \$145.89	NC11TEE \$165.35	NC12TEE \$175.06
	NC6ECL \$27.69	NC7ECL \$29.48	NC8ECL \$31.91	NC9ECL \$46.67	NC10ECL \$48.61	NC11ECL \$52.52	NC12ECL \$54.47
	NC6EC \$15.80	NC7EC \$17.43	NC8EC \$18.49	NC9EC \$33.06	NC10EC \$35.02	NC11EC \$36.96	NC12EC \$38.91
	NC6T18SL \$57.06	NC7T18SL \$63.70	NC8T18SL \$67.82	Custom	Custom	Custom	Custom
	NC6T18S \$50.47	NC7T18S \$57.06	NC8T18S \$61.19	Custom	Custom	Custom	Custom
	NC6T24SL \$76.10	NC7T24SL \$85.19	NC8T24SL \$90.58	Custom	Custom	Custom	Custom
	NC6T24S \$69.46	NC7T24S \$78.59	NC8T24S \$83.95	Custom	Custom	Custom	Custom

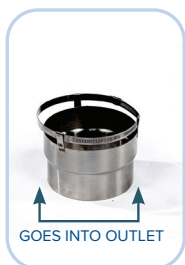

**STOVE
ADAPTER SA**



**FIXED TEE
FXTL(L)**



**PELLET TEE
FXTP**



**2 PART TEE
TEE(L)/FLEXT(L)**

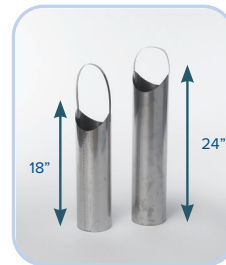

**EXTENDED TEE
SNOOTS SL/S**



**TEE END
CAP EC(L)**

Round Stainless Steel Components

	3"	4"	5"	5.5"	
Top/Support Clamp 304	NC3TC \$15.55	NC4TC \$15.85	NC5TC \$15.90	NC5.5TC \$16.67	
Top Kit 304 13" x 13"	NC3TK \$70.81	NC4TK \$74.54	NC5TK \$79.67	NC5.5TK \$85.27	
13" x 18"	NC3TK1318 \$76.34	NC4TK1318 \$80.11	NC5TK1318 \$85.25	NC5.5TK1318 \$90.83	
18" x 18"	NC3TK1818 \$78.20	NC4TK1818 \$81.97	NC5TK1818 \$87.07	NC5.5TK1818 \$92.67	
Premier Top Kit 13" x 13"	NC3PTK \$94.89	NC4PTK \$94.89	NC5PTK \$94.89	NC5.5PTK \$94.89	
13" x 18"	NC3PTK1318 \$101.71	NC4PTK1318 \$101.71	NC5PTK1318 \$101.71	NC5.5PTK1318 \$101.71	
18" x 18"	NC3PTK1818 \$120.36	NC4PTK1818 \$120.36	NC5PTK1818 \$120.36	NC5.5PTK1818 \$120.36	
Premier Top Kit Flue Fit 13" x 13"	NC3PTKFF \$116.07	NC4PTKFF \$116.07	NC5PTKFF \$116.07	NC5.5PTKFF \$116.07	
13" x 18"	NC3PTKFF1318 \$119.04	NC4PTKFF1318 \$119.04	NC5PTKFF1318 \$119.04	NC5.5PTKFF1318 \$119.04	
18" x 18"					
Top Kit 304 13" x 13"	NC3TKD \$90.74	NC4TKD \$90.74	NC5TKD \$109.47		
Top Kit 304 13" x 18"					
Top Kit Rain Cap (Fits top plate EZ collar)	NC3TKRC \$39.89	NC4TKRC \$39.89	NC5TKRC \$45.20	NC5.5TKRC \$48.40	

Double Take-Off Swivel Tee

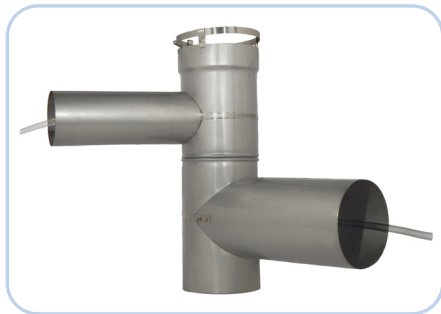

This style tee has two take-offs with a unique feature of the tee body having the capability to spin 360°. This enables both take-offs to act independently of each other and allows you to position each take-off to whatever angle is required. **Standard 2 inches between the take-offs.**

This tee has all the standard features of our regular two-part tee with removable take-offs and EZ Band Connection at the top of the tee. Made from 24ga 316 stainless steel.

	5"	5.5"	6"	7"	8"
3	NC5FLEXTLST/3 \$125.97	NC5.5FLEXTLST/3 \$132.72	NC6FLEXTLST/3 \$132.72	NC7FLEXTLST/3 \$164.24	NC8FLEXTLST/3 \$195.75
4	NC5FLEXTLST/4 \$128.31	NC5.5FLEXTLST/4 \$135.08	NC6FLEXTLST/4 \$133.51	NC7FLEXTLST/4 \$166.58	NC8FLEXTLST/4 \$198.09

Swivel Top Tee



This swivel top tee has a top liner connection which spins 360°. During liner installation it is sometimes difficult to get the tee body connection to align properly with the thimble. The advantage to

this swivel feature is you can spin the tee body from the thimble without having to turn the entire liner from the top of the chimney. This tee will save valuable time from having to turn the liner by hand at the top of the chimney. This tee has all the same features as our standard 24ga 316 and 304 style tees.

316		304	
NC4FLEXTLST	\$82.70	NC4FLEXTST	\$63.07
NC5FLEXTLST	\$86.56	NC5FLEXTST	\$64.74
NC5.5FLEXTLST	\$91.87	NC5.5FLEXTST	\$68.93
NC6FLEXTLST	\$91.87	NC6FLEXTST	\$68.93
NC7FLEXTLST	\$103.12	NC7FLEXTST	\$73.08
NC8FLEXTLST	\$109.56	NC8FLEXTST	\$87.91

	6"	7"	8"	9"	10"	11"	12"
	NC6TC \$16.67	NC7TC \$16.70	NC8TC \$18.82	NC9TC \$20.89	NC10TC \$23.27	NC11TC \$26.86	NC12TC \$29.08
	NC6TK \$85.27	NC7TK \$91.29	NC8TK \$97.85	NC9TK \$105.19	NC10TK \$124.83	Custom	Custom
	NC6TK1318 \$90.83	NC7TK1318 \$96.85	NC8TK1318 \$103.40	Custom	Custom	Custom	Custom
	NC6TK1818 \$92.67	NC7TK1818 \$98.70	NC8TK1818 \$105.23	NC9TK1818 \$120.43	NC10TK1818 \$150.35	NC11TK1818 \$166.12	NC12TK1818 \$182.44
	NC6PTK \$94.89	NC7PTK \$117.78	NC8PTK \$117.78	Custom	Custom	Custom	Custom
	NC6PTK1318 \$101.71	NC7PTK1318 \$101.71	NC8PTK1318 \$101.71	Custom	Custom	Custom	Custom
	NC6PTK1818 \$120.36	NC7PTK1818 \$120.36	NC8PTK1818 \$120.36	Custom	Custom	Custom	Custom
	NC6PTKFF \$116.07	NC7PTKFF \$116.07	NC8PTKFF \$116.07	Custom	Custom	Custom	Custom
	NC6PTKFF1318 \$119.04	NC7PTKFF1318 \$119.04	NC8PTKFF1318 \$119.04	Custom	Custom	Custom	Custom
	NC6PTKFF1818 \$124.27	NC7PTKFF1818 \$124.27		Custom	Custom	Custom	Custom
	NC6TKD \$109.47	NC7TKD \$118.13	NC8TKD \$126.90	NC9TKD \$136.54			
	NC6TKD1318 \$115.03					NC11TKD1318 \$206.35	
	NC6TKRC \$48.40	NC7TKRC \$53.61	NC8TKRC \$58.14	NC9TKRC \$65.07	NC10TKRC \$66.64		



TOP/SUPPORT CLAMP TC



TOP KIT TK



PREMIER TOP KIT PTK



FLUE FIT PREMIER TOP KIT TKFF

Top Kit Extensions

The Top Kit Extension is a section of rigid pipe made from 24ga 304 stainless steel that can be used to extend the height of the chimney to gain additional draft capacity for a poor performing chimney. Used in conjunction with our National Chimney Top Kit, simply remove the rain cap section from the top kit and install the rigid section inside the collar of the EZ Top Plate. Tighten the EZ Clamp around the collar of the EZ Top Plate securing the rigid section to the top plate making one complete unit. The extension piece has a bead connection at the top to attach the rain cap.

Offered in 18" and 24" lengths. Top plate & rain cap not included.



	5"	5.5"	6"	7"	8"
18"	NC5TKEXT18 \$53.06	NC5.5TKEXT18 \$57.08	NC6TKEXT18 \$57.08	NC7TKEXT18 \$67.16	NC8TKEXT18 \$76.03
24"	NC5TKEXT24 \$70.41	NC5.5TKEXT24 \$74.43	NC6TKEXT24 \$74.43	NC7TKEXT24 \$84.49	NC8TKEXT24 \$93.35

Round Stainless Steel Components

	3"	4"	5"	5.5"	
EZ Flue Fit Top Plate, 24ga 304 9" x 9"	NC3TPEZFF99 \$51.63	NC4TPEZFF99 \$51.63	NC5TPEZFF99 \$51.63	NC5.5TPEZFF99 \$51.63	
9" x 13" 304	NC3TPEZFF913 \$55.59	NC4TPEZFF913 \$55.59	NC5TPEZFF913 \$55.59	NC5.5TPEZFF913 \$55.59	
13" x 13" 304	NC3TPEZFF \$59.29	NC4TPEZFF \$59.29	NC5TPEZFF \$59.29	NC5.5TPEZFF \$59.29	
EZ Top Plate, 24ga 304 9" x 13"	NC3TPEZ913 \$31.48	NC4TPEZ913 \$31.48	NC5TPEZ913 \$31.48	NC5.5TPEZ913 \$31.48	
13" x 13"	NC3TPEZ \$35.33	NC4TPEZ \$35.33	NC5TPEZ \$35.33	NC5.5TPEZ \$35.33	
13" x 18"	NC3TPEZ1318 \$38.91	NC4TPEZ1318 \$38.91	NC5TPEZ1318 \$38.91	NC5.5TPEZ1318 \$38.91	
18" x 18"	NC3TPEZ1818 \$48.99	NC4TPEZ1818 \$48.99	NC5TPEZ1818 \$48.99	NC5.5TPEZ1818 \$48.99	
Top Plate, 18ga 304 9" x 9"	NC3TP99 \$26.74	NC4TP99 \$26.74	NC5TP99 \$26.74	NC5.5TP99 \$26.74	
9" x 13"	NC3TP913 \$26.74	NC4TP913 \$26.74	NC5TP913 \$26.74	NC5.5TP913 \$26.74	
13" x 13"	NC3TP \$27.09	NC4TP \$27.09	NC5TP \$27.09	NC5.5TP \$27.09	
13" x 18"	NC3TP1318 \$37.58	NC4TP1318 \$37.58	NC5TP1318 \$37.58	NC5.5TP1318 \$37.58	
18" x 18"	NC3TP1818 \$42.61	NC4TP1818 \$42.61	NC5TP1818 \$42.61	NC5.5TP1818 \$42.61	
Universal Takeoff 316	NC3UTOL \$36.65	NC4UTOL \$38.77	NC5UTOL \$41.15	Custom	

	5"	5.5"	6"	7"	
Stainless Steel Mesh Bottom Plate 18" x 18"		NC5.5BPMESHSS \$62.25	NC6BPMESHSS \$62.25	NC7BPMESHSS \$62.25	
Galvanized Mesh Bottom Plate 18" x 18"		NC5.5BPMESH \$41.75	NC6BPMESH \$41.75	NC7BPMESH \$41.75	

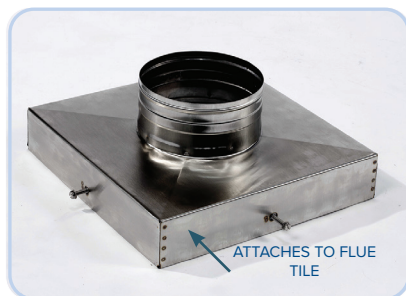

**EZ FLUE FIT
TOP PLATE
EZFF**

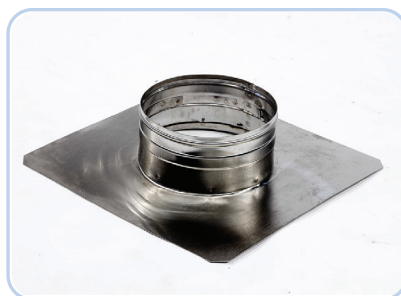

**EZ TOP PLATE
TPEZ**



**TOP PLATE
TP**

CHIMNEY COMPONENTS

	6"	7"	8"	9"	10"	11"	12"
	NC6TPEZFF99 \$51.63	NC7TPEZFF99 \$51.63	Custom	Custom	Custom	Custom	Custom
	NC6TPEZFF913 \$55.59	NC7TPEZFF913 \$55.59	Custom	Custom	Custom	Custom	Custom
	NC6TPEZFF \$59.29	NC7TPEZFF \$59.29	NC8TPEZFF \$59.29	Custom	Custom	Custom	Custom
	NC6TPEZ913 \$31.48	NC7TPEZ913 \$31.48	Custom	Custom	Custom	Custom	Custom
	NC6TPEZ \$35.33	NC7TPEZ \$35.33	NC8TPEZ \$35.33	NC9TPEZ \$36.69	NC10TPEZ \$36.69	NC11TPEZ \$36.69	Custom
	NC6TPEZ1318 \$38.91	NC7TPEZ1318 \$38.91	NC8TPEZ1318 \$38.91	Custom	Custom	Custom	Custom
	NC6TPEZ1818 \$48.99	NC7TPEZ1818 \$48.99	NC8TPEZ1818 \$48.99	NC9TPEZ1818 \$57.43	NC10TPEZ1818 \$57.43	NC11TPEZ1818 \$57.43	NC12TPEZ1818 \$57.43
	NC6TP99 \$26.74	NC7TP99 \$26.74	Custom	Custom	Custom	Custom	Custom
	NC6TP913 \$26.74	NC7TP913 \$26.74	Custom	Custom	Custom	Custom	Custom
	NC6TP \$27.09	NC7TP \$27.09	NC8TP \$27.09	NC9TP \$27.09	NC10TP \$27.09	Custom	Custom
	NC6TP1318 \$37.58	NC7TP1318 \$37.58	NC8TP1318 \$37.58	NC9TP1318 \$37.58	NC10TP1318 \$37.58	NC11TP1318 \$37.58	Custom
	NC6TP1818 \$42.61	NC7TP1818 \$48.99	NC8TP1818 \$48.99	NC9TP1818 \$48.99	NC10TP1818 \$48.99	NC11TP1818 \$48.99	NC12TP1818 \$48.99
	NC6UTOL \$43.67	NC7UTOL \$58.34	NC8UTOL \$57.59	Custom	Custom	Custom	Custom

	8"	9"	10"	11"	12"	14"	16"
	NC8BPMESHSS \$62.25	NC9BPMESHSS \$62.25	NC10BPMESHSS \$65.40	NC11BPMESHSS \$65.40	NC12BPMESHSS \$65.40	NC14BPMESHSS \$66.97	NC16BPMESHSS \$66.97
	NC8BPMESH \$41.75	NC9BPMESH \$41.75	NC10BPMESH \$44.90	NC11BPMESH \$44.90	NC12BPMESH \$44.90	NC14BPMESH \$46.47	NC16BPMESH \$46.47



UNIVERSAL TAKEOFF
UTO(L)

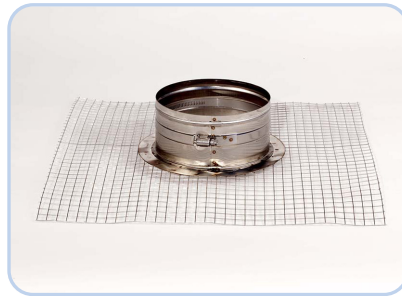

MESH BOTTOM PLATE



Elbows for All Fuel Applications

	3"		4"		5"		
	for RIGID or OD FLEX pipe	for FLEX pipe	for RIGID or OD FLEX pipe	for FLEX pipe	for RIGID or OD FLEX pipe	for FLEX pipe	
15 deg, fixed 316	NC315SSFL \$40.74	NC315FLEXSSFL \$46.77	NC415SSFL \$41.17	NC415FLEXSSFL \$47.65	NC515SSFL \$41.59	NC515FLEXSSFL \$48.18	
15 deg, fixed 304	NC315SSF \$33.79	NC315FLEXSSF \$39.87	NC415SSF \$34.23	NC415FLEXSSF \$40.74	NC515SSF \$34.64	NC515FLEXSSF \$41.23	
30 deg, fixed 316	NC330SSFL \$40.74	NC330FLEXSSFL \$46.77	NC430SSFL \$41.17	NC430FLEXSSFL \$47.65	NC530SSFL \$41.59	NC530FLEXSSFL \$48.18	
30 deg, fixed 304	NC330SSF \$33.79	NC330FLEXSSF \$39.87	NC430SSF \$34.23	NC430FLEXSSF \$40.74	NC530SSF \$34.64	NC530FLEXSSF \$41.23	
45 deg, fixed 316	NC345SSFL \$40.74	NC345FLEXSSFL \$46.77	NC445SSFL \$41.17	NC445FLEXSSFL \$47.65	NC545SSFL \$41.59	NC545FLEXSSFL \$48.18	
45 deg, fixed 304	NC345SSF \$33.79	NC345FLEXSSF \$39.87	NC445SSF \$34.23	NC445FLEXSSF \$40.74	NC545SSF \$34.64	NC545FLEXSSF \$41.23	
45 deg, adjustable	Custom	Custom	Custom	Custom	NC545SSL \$43.32	NC545FLEXSSL \$48.53	
45 deg, adjustable	Custom	Custom	Custom	Custom	NC545SS \$36.39	NC545FLEXSS \$42.98	
60 deg, fixed 316	NC360SSFL \$40.74	NC360FLEXSSFL \$46.77	NC460SSFL \$41.17	NC460FLEXSSFL \$47.65	NC560SSFL \$41.59	NC560FLEXSSFL \$48.18	
60 deg, fixed 304	NC360SSF \$33.79	NC360FLEXSSF \$39.87	NC460SSF \$34.23	NC460FLEXSSF \$40.74	NC560SSF \$34.64	NC560FLEXSSF \$41.23	
90 deg, fixed 316	NC390SSFL \$44.20	NC390FLEXSSFL \$50.25	NC490SSFL \$44.64	NC490FLEXSSFL \$51.13	NC590SSFL \$45.05	NC590FLEXSSFL \$51.64	
90 deg, fixed 304	NC390SSF \$37.27	NC390FLEXSSF \$43.32	NC490SSF \$37.69	NC490FLEXSSF \$44.20	NC590SSF \$38.13	NC590FLEXSSF \$44.72	
90 deg, adjustable	Custom	Custom	Custom	Custom	NC590SSL \$54.60	NC590FLEXSSL \$59.78	
90 deg, adjustable	Custom	Custom	Custom	Custom	NC590SS \$51.83	NC590FLEXSS \$57.03	

Stainless Steel

Adjustable & Fixed Elbows



are available in 3"– 8" diameters. Elbows are used for rigid and outside diameter "OD" flex pipe or for inside diameter "ID" flex pipe in a multitude of degrees. Manufacturing our own elbows allows for a top quality product with an unsurpassed fit. So the next time you have a tricky installation that requires the versatility of an adjustable or fixed elbow, call National Chimney for your solution.



**45 DEG ADJ.
FOR FLEX
45FLEXSSF(L)**



**45 DEG FIXED
FOR RIGID
45SSF(L)**

CHIMNEY COMPONENTS

	6"		7"		8"	
	for RIGID or OD FLEX pipe	for FLEX pipe	for RIGID or OD FLEX pipe	for FLEX pipe	for RIGID or OD FLEX pipe	for FLEX pipe
NC615SSFL \$45.93	NC615FLEXSSFL \$51.13	NC715SSFL \$49.82	NC715FLEXSSFL \$52.39	NC815SSFL \$55.02	NC815FLEXSSFL \$60.20	
NC615SSF \$38.98	NC615FLEXSSF \$44.20	NC715SSF \$42.90	NC715FLEXSSF \$48.08	NC815SSF \$48.08	NC815FLEXSSF \$53.30	
NC630SSFL \$45.93	NC630FLEXSSFL \$51.13	NC730SSFL \$47.44	NC730FLEXSSFL \$55.02	NC830SSFL \$55.02	NC830FLEXSSFL \$60.20	
NC630SSF \$38.98	NC630FLEXSSF \$44.20	NC730SSF \$42.90	NC730FLEXSSF \$48.08	NC830SSF \$48.08	NC830FLEXSSF \$53.30	
NC645SSFL \$45.93	NC645FLEXSSFL \$51.13	NC745SSFL \$47.44	NC745FLEXSSFL \$55.02	NC845SSFL \$55.02	NC845FLEXSSFL \$60.20	
NC645SSF \$38.98	NC645FLEXSSF \$44.20	NC745SSF \$42.90	NC745FLEXSSF \$48.08	NC845SSF \$48.08	NC845FLEXSSF \$49.25	
NC645SSL \$51.13	NC645FLEXSSL \$56.33	NC745SSL \$52.39	NC745FLEXSSL \$61.53	NC845SSL \$60.20	NC845FLEXSSL \$67.16	
NC645SS \$40.74	NC645FLEXSS \$45.93	NC745SS \$44.64	NC745FLEXSS \$49.82	NC845SS \$49.82	NC845FLEXSS \$53.30	
NC660SSFL \$45.93	NC660FLEXSSFL \$51.13	NC760SSFL \$47.44	NC760FLEXSSFL \$55.02	NC860SSFL \$55.02	NC860FLEXSSFL \$60.20	
NC660SSF \$38.98	NC660FLEXSSF \$44.20	NC760SSF \$42.90	NC760FLEXSSF \$48.08	NC860SSF \$48.08	NC860FLEXSSF \$53.30	
NC690SSFL \$49.41	NC690FLEXSSFL \$54.60	NC790SSFL \$50.73	NC790FLEXSSFL \$58.49	NC890SSFL \$58.49	NC890FLEXSSFL \$63.67	
NC690SSF \$42.46	NC690FLEXSSF \$47.65	NC790SSF \$46.36	NC790FLEXSSF \$51.55	NC890SSF \$51.55	NC890FLEXSSF \$56.77	
NC690SSL \$60.20	NC690FLEXSSL \$65.42	NC790SSL \$62.30	NC790FLEXSSL \$70.64	NC890SSL \$72.33	NC890FLEXSSL \$79.29	
NC690SS \$57.03	NC690FLEXSS \$62.22	NC790SS \$60.20	NC790FLEXSS \$65.36	NC890SS \$69.64	NC890FLEXSS \$74.87	

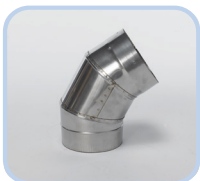

60 DEG FIXED FOR RIGID 60SSF(L)



60 DEG FIXED FOR FLEX 60FLEXSSF(L)



90 DEG FIXED FOR RIGID 90SSF(L)



90 DEG FIXED FOR FLEX 90FLEXSSF(L)



15 DEG FIXED FOR FLEX 15FLEXSSF(L)



30 DEG FIXED FOR FLEX 30FLEXSSF(L)

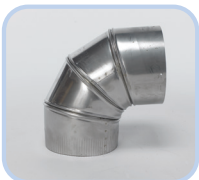

90 DEG ADJ. FOR RIGID 90SS(L)



90 DEG ADJ. FOR FLEX 0FLEXSS(L)

Increaser/Reducer for All Fuel Applications



Increaser/Reducer

National Chimney does not crimp our reducer/increaser so you can choose which end needs crimping for your application. Reducer/Increasesers are available in 304 (wood and wood pellet applications) or 316 (all fuel applications). Choose from a 3 piece/tapered design for maximum flow or our plug style for tight spots. National Chimney offers a reducer made specifically for pellet stove installations. The 4"- 3" pellet reducer is also available as a 3 piece/tapered design or plug style. The 4" female end attaches to the outside of our M-FLEX or Smoothwall Liner then goes directly to the outside of the 3" pellet stove opening.

FOR ALL FUEL (L), WOOD AND WOOD PELLET APPLICATIONS

	4" - 3"	4"-3" PELLET	5" - 3"	5" - 4"	6" - 3"	6" - 4"	6" - 5"	7" - 3"	7" - 4"
316	NC43R/IL \$43.34	Custom	NC53R/IL \$45.59	NC54R/IL \$46.47	NC63R/IL \$41.40	NC64R/IL \$47.72	NC65R/IL \$48.74	NC73R/IL \$41.40	Custom
304	NC43R/I \$32.18	NC43R/IPELLET \$44.75	NC53R/I \$37.52	NC54R/I \$37.52	NC63R/I \$37.91	NC64R/I \$37.52	NC65R/I \$37.52	NC73R/I \$37.91	NC74R/I \$38.02

	7" - 5"	7" - 6"	8" - 6"	8" - 7"	9" - 7"	9" - 8"	10" - 8"	10" - 9"	
316	NC75R/IL \$49.71	NC76R/IL \$50.06	NC86R/IL \$51.39	NC87R/IL \$51.39	NC97R/IL \$54.52	NC98R/IL \$56.24	NC108R/IL \$59.92	NC109R/IL \$59.92	
304	NC75R/I \$38.90	NC76R/I \$38.90	NC86R/I \$40.25	NC87R/I \$40.25	NC97R/I \$43.59	NC98R/I \$43.59	NC108R/I \$51.46	NC109R/I \$50.98	

Please Note: For "Plug Style" reducers/increasers, add a "P" to the part # above. For example, NC43R/IP. These reducers/increasers are made to fit our Rigid Lining Systems. For connecting to all other liners, please order an ID coupler to transition from the liner to the reducer/increaser.

ORDERING OVALIZED TEES AND NOSE CONES?

You need to know what your ID (Inside Diameter) or OD (Outside Diameter) of the round liner (before the liner is ovalized). For example, if the liner was a CB625 (which is ID) and it was ovalized down to 5", you would need an ID tee = NC65OVFLEXT. If the liner was a CB625OD (which is OD) you would need an OD tee = NC65OVTEE.

HOW DO I CONNECT TWO PIECES OF OVALIZED LINER?

We ovalize our couplers with the liner for an exact fit every time, so if you need a coupler just order the coupler that would fit the round liner and ask us to ovalize it with your liner. For example, if you ordered an 8" ID liner, you would need to order an NC8C (in 304 for wood applications) or NC8CL (in 316 for all fuel applications). If it was an 8" OD liner then you would need an NC8COD or NC8CODL.



OVAL TO ROUND ADAPTER

The oval end of the adapter is made to accept ovalized Inside Diameter (ID) liner. The round bottom end is crimped and made to go into stovepipe or inside the stove's collar.

OVRD(L)



If you are running liner between the tees, then you will need to order an extra tee, the same as the first one ordered to accommodate the liner.

4-3 PELLET ADAPTER
NC43R/IPELLET1: **\$39.38**



Insert Boot

National Chimney manufactures insert boots with 24ga 304 stainless steel. They are designed to attach rigid pipe or flexible liner with a coupler to the exhaust vent of most inserts.

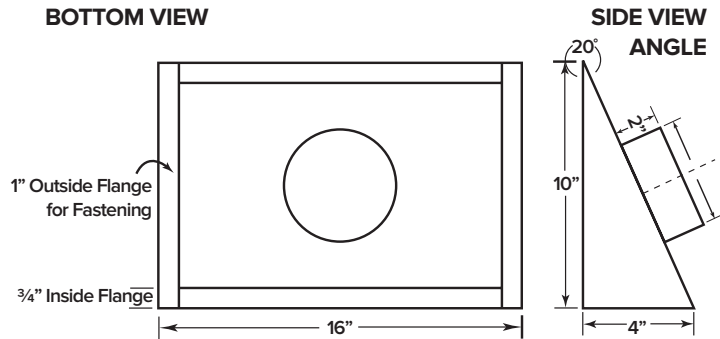
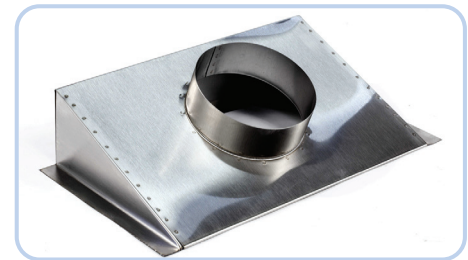

6"	NCSS6B \$110.89
7"	NCSS7B \$111.73
8"	NCSS8B \$120.94
Small Oval measures: 4.5"x10.5"	NCSSSO \$128.90
Large measures: 4.5"x13.5"	NCSSLO \$133.45

Insert Adapter

National Chimney manufactures a unique insert adapter that allows a front-to-back or a side-to-side adjustment in the firebox. The two piece design allows it to slide to adjust the center-to-center distance of the collars. This accommodates a horizontal offset from 0" to 9" without the added clearance required for elbows. The top collar accepts OD flex liner or rigid pipe. It will also accept ID pipe in conjunction with a coupler. The bottom collar will fit into most stoves that require a crimped connection. Attaches with screws or rivets like most liner or pipe. Custom adapters are also available with clean-out door.

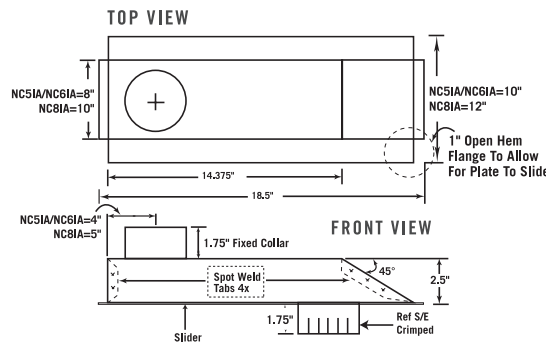

5"	NC51A \$112.35
6"	NC61A \$120.43
8"	NC81A \$132.66

Stove adapter required to connect to M-FLEX Liner.

Liner Insert Adapter

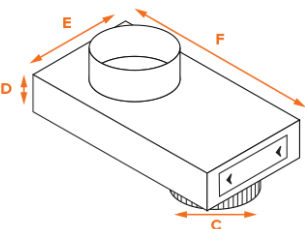

Item	A	B	C	D	E	F
3320	6 3/8" ID	2 1/4"	5 1/16" OD	3 1/8"	8 1/4"	13 1/2"
3322	8 3/8" ID	2 1/4"	7 1/16" OD	3 1/8"	10 1/4"	16 1/16"

Offset Adjustments from 6" to 12"

National Chimney manufactures a unique Insert Adapter that allows a front-to-back and side-to-side adjustment in the firebox. The two-piece design allows the unit to slide to adjust the center distance between collars. The 6" adapter when fully closed has a 6" center-to-center measurement and when fully extended has a 12" measurement between the collars. The 8" adapter has a 7" measurement between the centers of the collars and a 12" distance between collars when fully open. The top collar on both 6" and 8" adapters accepts "I.D." Flex Liner and the bottom collar is crimped to fit into most stoves or inserts. Made from 24ga 304 stainless steel this adapter attaches with self-tapping screws or rivets. Clean-out door comes standard.

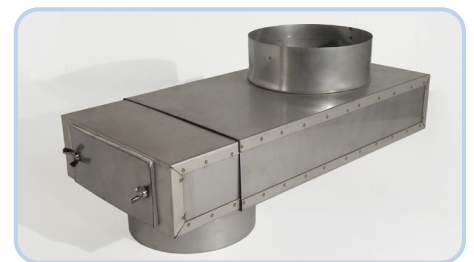

6"	NC61A \$120.43
8"	NC81A \$132.66

Custom sizes available.

Oval Components for All Fuel & Wood Applications

Oval components are made in-house to fit any M-FLEX or Premier Flex ovalized liners. When deciphering what parts you need, the first number is the round liner size. The second number is what it is ovalized down to.

(Example: NC65OVNC=National Chimney 6" ID round Wed down to 5" Nose Cone) See Dimension Sizing Chart.



	8" OVAL TO 7"	8" OVAL TO 6"	8" OVAL TO 5.5"	7" OVAL TO 6"	7" OVAL TO 5"	6" OVAL TO 5"
2 Part Flex Tee ID 316	NC87OVFLEXL \$132.74	NC87OVFLEXL \$132.74	NC85.5OVFLEXL \$132.74	NC76OVFLEXL \$122.58	NC75OVFLEXL \$122.58	NC65OVFLEXL \$122.58
2 Part Flex Tee ID 304	NC87OVFLEXT \$108.93	NC86OVFLEXT \$108.93	NC85.5OVFLEXT \$108.93	NC76OVFLEXT \$98.04	NC75OVFLEXT \$98.04	NC65OVFLEXT \$98.04
2 Part Tee OD 316	NC87OVTEEL \$132.74	NC86OVTEEL \$132.74	NC85.5OVTEEL \$132.74	NC76OVTEEL \$122.58	NC75OVTEEL \$122.58	NC65OVTEEL \$122.58
2 Part Tee OD 304	NC87OVTEE \$108.93	NC86OVTEE \$108.93	NC85.5OVTEE \$108.93	NC76OVTEE \$98.04	NC75OVTEE \$98.04	NC65OVTEE \$98.04
Tee End Cap 316	NC87OVECL \$38.91	NC86OVECL \$38.89	NC85.5OVECL \$38.91	NC76OVECL \$38.91	NC75OVECL \$38.91	NC65OVECL \$38.91
Tee End Cap 304	NC87OVEC \$35.02	NC86OVEC \$35.02	NC85.5OVEC \$35.02	NC76OVEC \$35.02	NC75OVEC \$35.02	NC65OVEC \$35.02
Nose Cone ID 304	NC87OVNC \$81.70	NC86OVNC \$81.70	Custom	NC76OVNC \$61.28	NC75OVNC \$61.28	NC65OVNC \$61.28
Nose Cone OD 304	NC87OVNCOD \$81.70	NC86OVNCOD \$81.70	Custom	NC76OVNCOD \$61.28	NC75OVNCOD \$61.28	NC65OVNCOD \$61.28
Top Plate, 18 ga 304 9 x 9	Custom	Custom	Custom	Custom	Custom	NC65OVTP99 \$32.11
9 x 13, 18 ga 304	NC87OVTP913 \$32.11	NC86OVTP913 \$32.11	NC85.5OVTP913 \$32.11	NC76OVTP913 \$32.11	NC75OVTP913 \$32.11	NC65OVTP913 \$32.11
13 x 13, 18 ga 304	NC87OVTP \$36.40	NC86OVTP \$36.40	NC85.5OVTP \$36.40	NC76OVTP \$36.40	NC75OVTP \$36.40	NC65OVTP \$36.40
13 x 18, 18 ga 304	NC87OVTP1318 \$42.78	NC86OVTP1318 \$42.78	NC85.5OVTP1318 \$42.78	NC76OVTP1318 \$42.78	NC75OVTP1318 \$42.78	NC65OVTP1318 \$42.78
18 x 18, 18 ga304	NC87OVTP1818 \$64.18	NC86OVTP1818 \$64.18	NC85.5OVTP1818 \$64.18	NC76OVTP1818 \$64.18	NC75OVTP1818 \$64.18	NC65OVTP1818 \$64.18
Top/Support Clamp 304	NC87OVTC \$31.32	NC86OVTC \$31.32	NC85.5OVTC \$31.32	NC76OVTC \$29.08	NC75OVTC \$29.08	NC65OVTC \$29.08
Storm Collar 304	NC87OVSC \$43.59	NC86OVSC \$43.59	NC85.5OVSC \$43.59	NC76OVSC \$43.59	NC75OVSC \$43.59	NC65OVSC \$43.59
Rain Cap 304	NC87OVRC \$88.91	NC86OVRC \$88.91	Custom	NC76OVRC \$83.06	NC75OVRC \$83.06	NC65OVRC \$66.45
Oval to Round Adapter 316	NC87OVRDL \$105.59	NC86OVRDL \$105.59	Custom	NC76OVRDL \$95.23	NC75OVRDL \$95.23	NC65OVRDL \$90.03



END CAP



STORM COLLAR



NOSE CONE



TEE



TOP PLATE



TOP CLAMP



COUPLER EZ



LINER CAP

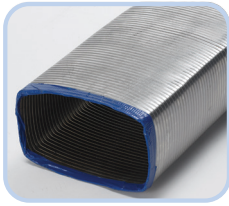

Premier Flex

Rectangle & Square Components

FOR WOOD & WOOD PELLET APPLICATIONS



	5.75" x 9.5"	6" x 10"	7" x 11"	8" x 12"	10" x 10"	11" x 11"
Coupler OD	NC5.759.5C \$38.50	NC610C \$40.56	NC711C \$42.71	NC812C \$46.99	NC1010C \$57.79	NC1111C \$59.91
2 Part Tee (w/ round takeoff on wide side)	NC5.759.5TR \$119.82	NC610TR \$119.82	NC711TR \$126.44	NC812TR \$136.18	Custom	Custom
Tee End Cap	NC5.759.5EC \$35.02	NC610EC \$35.02	NC711EC \$35.02	NC812EC \$38.91	Custom	Custom
Nose Cone	NC5.759.5NC \$61.28	NC610NC \$71.50	NC711NC \$81.70	NC812NC \$89.86	NC1010NC \$92.62	NC1111NC \$96.33
Top Plate, 18 ga 13" x 13"	NC5.759.5TP \$32.11	NC610TP \$32.11	NC711TP \$32.11		NC1010TP \$32.11	
13" x 18"	NC5.759.5TP1318 \$36.21	NC610TP1318 \$36.21	NC711TP1318 \$36.21	NC812TP1318 \$36.21	NC1010TP1318 \$58.34	NC1111TP1318 \$58.34
18" x 18"	NC5.759.5TP1818 \$57.79	NC610TP1818 \$57.79	NC711TP1818 \$57.79	NC812TP1818 \$57.79	NC1010TP1818 \$64.18	NC1111TP1818 \$64.18
Bottom Plate, 18 ga 13" x 13"	NC5.759.5BP \$52.52	NC610BP \$52.52	NC711BP \$52.52		NC1010BP \$46.91	Custom
13" x 18"	NC5.759.5BP1318 \$58.34	NC610BP1318 \$58.34	NC711BP1318 \$58.34	NC812BP1318 \$58.34	NC1010BP1318 \$58.34	NC1111BP1318 \$58.34
18" x 18"	NC5.759.5BP1818 \$77.83	NC610BP1818 \$77.83	NC711BP1818 \$77.83	NC812BP1818 \$77.81	NC1010BP1818 \$77.83	NC1111BP1818 \$77.83
Top Support Clamp	NC5.759.5TC \$31.32	NC610TC \$31.32	NC711TC \$33.55	NC812TC \$33.55	NC1010TC \$33.55	NC1111TC \$33.55
Storm Collar	NC5.759.5SC \$52.16	NC610SC \$52.16	NC711SC \$52.16	NC812SC \$52.16	NC1010SC \$54.47	NC1111SC \$54.47
Rain Cap	NC5.759.5RC \$99.68	NC610RC \$99.68	NC711RC \$118.68	NC812RC \$118.68	NC1010RC \$129.70	NC1111RC \$129.70

	5.75" x 9.5"	6" x 10"	7" x 11"	8" x 12"
Stainless Steel Mesh Rectangle Bottom Plate 18" x 18"	NC57595BPMESHSS \$73.27	NC610BPMESHSS \$73.27	NC711BPMESHSS \$73.27	NC812BPMESHSS \$73.27
Galvanized Mesh Rectangle Bottom Plate 18" x 18"	NC57595BPMESH \$52.78	NC610BPMESH \$52.78	NC711BPMESH \$52.78	NC812BPMESH \$52.78



TEE



NOSE CONE



END CAP



RAIN CAP

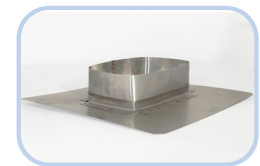

BOTTOM PLATE



MESH BOTTOM PLATE



STORM COLLAR



TOP CLAMP



COUPLER

Insulation

Premier Mix

Insulation



Premier Mix insulation is a UL listed (to 1777), ready mix vermiculite based masonry material containing no asbestos. It helps keep heat in and allows the flue to stay warmer causing less creosote build up and less condensation in gas and oil applications.

**This Product does not qualify for free shipping.*

26 LB. BAG:
PRMIX: **\$41.09**



PREMIER MIX PREPARATION INSTRUCTIONS

Simply prepare by gradually adding 2 to 4 gallons of water. The product is properly mixed if when squeezed in your hand, it will hold together, no water should come out. Pour the mix around the chimney liner and let it solidify.

AREA OF ROUND LINERS IN SQUARE INCHES

C	3"	4"	5"	6"	7"	8"	9"	10"	11"	12"
	7.07	12.56	19.63	28.26	38.46	50.25	63.58	78.50	94.99	113.14

Two Other Types of Insulation Available:

VERMICULITE
VER: **\$49.68**

PREMIER MIX SIZING INSTRUCTIONS

Please use the following calculation as a guide. Keep in mind there may be voids or irregularities in the chimney you cannot see.

- STEP 1:** Multiply the inside dimensions of the chimney flue, e.g., 13" x 13".
- STEP 2:** Subtract the area of the liner to be installed in sq inches (see charts above).
- STEP 3:** Multiply that number by the height of the chimney in feet.
- STEP 4:** Divide by 216.

= Total number of bags of premier mix you will need to insulate the chimney.



CUSTOM PARTS

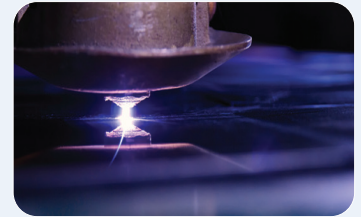
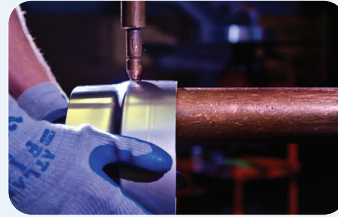

National Chimney is the leader in manufacturing custom components for all of your needs. Our custom shop is geared to meet your requirements in a timely fashion and give you quality parts at competitive prices.

**Custom Products do not qualify for free shipping.*

The Industry's LEADING Custom Shop. If You Can Draw It, We can Build It!



CUSTOM TEE

Choose:

- Removable or Rigid Snouts
- Body Length
- Snout Length
- Number of Snouts and Sizes



CUSTOM TOPS

Choose:

- Top Size
- Lid Style, Round or Square
- Screen Height



CUSTOM CAPS

Choose:

- Overall Dimensions
- Screen Height
- Number and Location of Holes



CHASE COVERS

15-year Warranty on Aluminum, Lifetime Warranty on Stainless Steel

Choose:

- Overall Dimensions
- Skirt Height
- Number and Location of Holes
- Copper or Stainless Steel

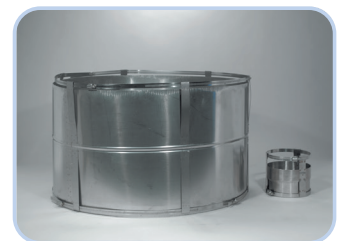

CUSTOM COUPLER

Choose:

- Sizes
- Slide IN or EZ Band Connection

Insulation

Premier Wrap

Insulation w/ 4 ml Foil



Premier Wrap Insulation comes with an 8 lb. density ceramic blanket and a durable 4 ml foil backing. Available in ¼" thickness which achieves a 1" clearance to combustibles and a ½" thickness providing a zero clearance requirement. Both are offered in 24", 30", 36" and 48" width by 25' and 35' long rolls. Please see the chart on the next page to assist you in ordering the correct width blanket for the corresponding diameter liner. Insulation comes in 25' or 35' lengths, so if your liner exceeds these lengths please order accordingly. The premier wrap is also available in a non-foil faced blanket that is 1" thick x 24" wide.



FITS LINER SIZES	INSULATION (WIDTH)	ROLL LENGTH	1/4" W/4ML FOIL	1/2" W/4ML FOIL	1" NON-FOIL
			ACHIEVES A 1" CLEARANCE TO COMBUSTIBLES	PROVIDES A ZERO CLEARANCE REQUIREMENT	
3" - 6"	24"	25'	PW46 \$122.56	PW26 \$144.75	4 lb Density PWNFF \$116.09
		35'	PW4635 \$169.45	PW2635 \$236.43	
7" - 8"	30"	25'	PW478 \$179.39	PW278 \$258.04	8 lb Density PWNFF8# \$153.34
		35'	PW47835 \$251.38	PW27835 \$361.01	
9" - 10"	36"	25'	PW4910 \$202.17	PW2910 \$289.50	
		35'	PW491035 \$283.32	PW291035 \$376.35	
11" - 14"	48"	25'	PW41114 \$245.21	PW21114 \$318.45	
		35'	PW4111435 \$338.43	PW2111435 \$357.05	

WHEN TO INSULATE...

	Insulation (Required for UL Listing)	Recommended for Better Results (Not Required for UL Listings)
Solid Fuels (Wood, Pellet, or Coal)	1" Premier Mix Insulation Or ½" Premier Wrap Insulation	1" Premier Mix Insulation Or ½" Premier Wrap Insulation
Gas	Not Required	Insulating the chimney liner will improve the performance of the appliance it is connected to. Insulating the liner will reduce condensation—especially on startup. Recommend ¼" Premier Wrap Insulation or any thickness Premier Mix Insulation.
Oil	Not Required	Insulating the chimney liner will improve the performance of the appliance it is connected to. Insulating the liner will reduce condensation—especially on startup. Recommend ¼" Premier Wrap Insulation or any thickness Premier Mix Insulation.

All wood, wood pellet and coal applications require insulation, while it is recommended with oil and gas appliances, it is not required. Insulate our liners with either Premier Mix, a vermiculite based poured insulation, or with Premier Wrap, a foil-faced ceramic wool blanket, to meet UL 1777 standards for chimney exteriors with zero clearance to combustibles.



Premier Wrap Insulation Kit



Includes:

- 4 ml Aluminum Backed Premier Wrap
- Premier Mesh
- Mesh Clamps
- Foil Tape
- Adhesive Spray

FITS LINER SIZES	INSULATION ROLL		1/4" W/4ML FOIL	1/2" W/4ML FOIL
	WIDTH	LENGTH	ACHIEVES A 1" CLEARANCE TO COMBUSTIBLES	PROVIDES A ZERO CLEARANCE REQUIREMENT
3" - 6"	24"	25'	PW46KIT \$172.72	PW26KIT \$191.12
		35'	PW4635KIT \$221.20	PW2635KIT \$276.72
7" - 8"	30"	25'	PW478KIT \$235.97	PW278KIT \$301.17
		35'	PW47835KIT \$307.49	PW27835KIT \$398.37



FOIL TAPE
3" X 150"
FOIL: \$27.71



STAINLESS STEEL WIRE
1 LB. COIL
FAS/SWIRE: \$71.93



ADHESIVE SPRAY
12 OZ. CAN
NSA: \$21.78

Premier Mesh



C FITS LINER SIZES			
3" - 6"	12" flat	25'	PM6 \$26.40
	12" flat	35'	PM6-35 \$38.40
7" - 9"	15" flat	25'	PM79 \$30.80
	15" flat	35'	PM79-35 \$45.60
10" - 11"	18" flat	25'	PM1011 \$37.70
	18" flat	35'	PM1011-35 \$50.80
12" +	24" flat	25'	PM12+ \$52.64
	24" flat	35'	PM12+35 \$71.22

Mesh Clamps

B FITS LINER SIZES		
3" - 8"	Small	FA1540 \$5.93
9" +	Large	FA1540LG \$7.47



Stove Pipe Components

Heat Fab 22Ga Single Wall Black Stovepipe And Components



(ALSO KNOWN AS SAF-T-LINER)



It's made from 22ga .030 cold roll steel with 100% laser or advanced resistance-welded seams. It is 60% thicker pipe than most hardware store brands and it guarantees a completely sealed seam which means no smoke or flue leakage. It is designed for interior use only, to vent coal or wood burning appliances. Available in a full range of parts and sizes individually wrapped and packaged for FedEx.

C	6"	7"	8"
12" Length	2602B \$40.05	2702B \$42.32	2802B \$42.32
18" Length	2604B \$47.12	2704B \$51.73	2804B \$51.73
24" Length	2605B \$53.48	2705B \$62.80	2805B \$62.80
36" Length	2607B \$76.15	2707B \$85.57	2807B \$85.57
48" Length	2608B \$98.95	2708B \$115.80	2808B \$115.80
38" - 70" Length Adj	2606B \$155.66	2706B \$185.79	2806B \$185.79
Slip Connector, 2"-16" Length Adj	2624B \$47.12	2724B \$51.73	2824B \$51.73
90 deg adj elbow	2614AB \$88.18	2714AB \$95.35	2814AB \$95.35
90 deg fixed elbow	2614B \$59.24	2714B \$65.08	2814B \$65.08
45 deg fixed elbow	2611B \$50.66	2711B \$53.08	2811B \$53.08
Fixed Tee	2616B \$76.15	2716B \$85.57	2816B \$85.57
Tee End Cap	2617B \$49.42	2717B \$65.08	2817B \$65.08
Tee Plug, Crimped	2617P \$71.20	2717P \$85.57	2817P \$85.57
Wall Trim Collar, Flat	2600B \$31.35	2700B \$31.35	2800B \$31.35

Round to Oval Adapters



Here is the solution to connect 8" round 22ga single wall black stovepipe to the stove. The centerline adapter is 11 1/2" high with a round female end accepting 8" pipe and an oval male end 53/8" x 93/4". The offset adapter is 93/4" high with a round female end accepting 8" pipe and an oval male end 53/8" x 93/4".



Saf-T-Increaser/Reducer

(NO CRIMP)

5" - 6"	6" - 7"	6" - 8"	7" - 8"
2635B \$42.32	2736B \$62.80	2836B \$51.73	2837B \$67.60

Heat Fab Saf-T-Thimbles

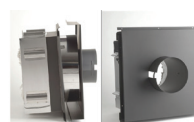

This easy to install thimble allows stove pipe to pass safely through walls to a masonry chimney flue. Heavy duty insulated steel construction shields the wall from heat, therefore reducing the 18" minimum clearance. This unique insulating factor allows for wall thickness of 4" - 8".



Fits 5", 6"	Fits 7", 8"
HF3006 \$534.09	HF3008 \$534.09

Heat Fab Saf-T-Wrap



Insulation is required for wood, wood pellet and coal applications. Oil and gas applications are recommended to be insulated, but not required. Heat-Fab Saf-T-Wrap is available in 2' sections and is an easy, convenient way to insulate our Rigid Lining System.



FOR LINER DIAMETER

6"	7"	8"	10"	11"
HF6SW \$65.18	HF7SW \$71.28	HF8SW \$77.34	HF10SW \$109.96	HF11SW \$130.47

Imperial Stovepipe



90 DEGREE
ADJUSTABLE ELBOW



STOVE PIPE



ROUND PIPE



TEE



INCRASER/
REDUCER



END CAP

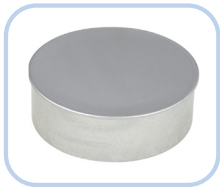

END CAP -
NO CRIMP

Black		
6" BM Connector DrawBand	IMB6CDB	\$22.83
6" BM Connector Union	IMB6CU	\$10.85
6" x 12" BM Connector Slip	IMB612SLIP	\$14.34
7" BM Connector DrawBand	IMB7CDB	\$24.78
7" x 6" BM Connector Oval-Rnd	IMB76OVRD	\$26.26
8" BM Connector DrawBand	IMB8CDB	\$26.83
8" BM Connector Union	IMB8CU	\$15.35
8" x 12" BM Connector Slip	IMB812SLIP	\$16.90
5" Cast Iron Damper	IMB5CID	\$8.03
6" Cast Iron Damper	IMB6CID	\$8.97
7" Cast Iron Damper	IMB7CID	\$10.90
8" Cast Iron Damper	IMB8CID	\$13.62
5" x 90deg BM Adj. Elbow	IMB590ELB	\$17.63
6" x 90deg BM Adj. Elbow	IMB690ELB	\$18.23
6" x 90deg BM Corrugated Elbow	IMB690ELBC	\$23.54
7" x 90deg BM Adj. Elbow	IMB790ELB	\$20.01
8" x 90deg BM Adj. Elbow	IMB890ELB	\$22.36
8" x 90deg BM Corrugated Elbow	IMB890ELBC	\$31.42
5" BM End Cap BE (No Crimp)	IMB5EC	\$16.51
6" BM End Cap BE (No Crimp)	IMB6EC	\$17.01
7" BM End Cap BE (No Crimp)	IMB7EC	\$18.44
8" BM End Cap BE (No Crimp)	IMB8EC	\$19.97
5"x6" BM Increaser (BE Crimp)	IMB56INC	\$28.09
6"x5" BM Reducer (SE Crimp)	IMB65RED	\$28.09
6"x7" BM Increaser (BE Crimp)	IMB67INC	\$29.35
6"x8" BM Increaser (BE Crimp)	IMB68INC	\$31.15
7"x6" BM Reducer (SE Crimp)	IMB76RED	\$29.35
7"x8" BM Increaser (BE Crimp)	IMB78INC	\$31.63
8"x6" BM Reducer (SE Crimp)	IMB86RED	\$31.15
8"x7" BM Reducer (SE Crimp)	IMB87RED	\$31.63
5" x 12" BM Pipe	IMB512	\$10.56
5" x 24" BM Pipe	IMB524	\$19.03
6" x 12" BM Pipe	IMB612	\$12.21
6" x 24" BM Pipe	IMB624	\$20.46
7" x 12" BM Pipe	IMB712	\$12.82
7" x 24" BM Pipe	IMB724	\$25.65
8" x 12" BM Pipe	IMB812	\$15.67
8" x 24" BM Pipe	IMB824	\$27.47
5" BM Assembled Tee	IMB5TEE	\$41.77
6" BM Assembled Tee	IMB6TEE	\$42.58
7" BM Assembled Tee	IMB7TEE	\$48.62
8" BM Assembled Tee	IMB8TEE	\$52.44
5" BM Trim Collar	IMB5TC	\$10.08
6" BM Trim Collar	IMB6TC	\$10.40
7" BM Trim Collar	IMB7TC	\$10.51
8" BM Trim Collar	IMB8TC	\$10.75
Ash Ctnr & Shovel Set BLK/DBTM	IMBASHSET	\$101.04
Ash Shovel, Black	IMBASHSOVEL	\$8.17
Burn Indicator Magnetic IMP	IMBIM	\$37.19
Circulating Fan /1pc	IMBCF	\$95.49
Coal Hod, Black	IMBCOALHOD	\$46.08
Firebrick 9"x4-1/2"x1-1/4	IMBFB	\$6.19
Stove Pipe Screws HEX /12pc	IMBSPS	\$4.96

Galvanized		
3" GV 90deg Adj Elbow 26ga	IMG390ELB26	\$8.00
3" GV 90deg Adj Elbow 28ga	IMG390ELB28	\$7.64
3" GV 90deg Adj Elbow 30ga	IMG390ELB30	\$7.32
4" GV 90deg Adj Elbow 26ga	IMG490ELB26	\$9.38
5" GV 90deg Adj Elbow 24ga	IMG590ELB24	\$13.92
5" GV 90deg Adj Elbow 26ga	IMG590ELB26	\$11.15
5" GV 90deg Adj Elbow 30ga	IMG590ELB30	\$8.00
6" GV 90deg Adj Elbow 24ga	IMG690ELB24	\$14.19
6" GV 90deg Adj Elbow 26ga	IMG690ELB26	\$11.38
6" GV 90deg Adj Elbow 30ga	IMG690ELB30	\$8.04
7" GV 90deg Adj Elbow 24g	IMG790ELB24	\$16.90
7" GV 90deg Adj Elbow 26ga	IMG790ELB26	\$14.16
7" GV 90deg Adj Elbow	IMG790ELB30	\$13.62
8" GV 90deg Adj Elbow 24g	IMG890ELB24	\$18.67
8" GV 90deg Adj Elbow 26ga	IMG890ELB26	\$16.90
8" GV 90deg Adj Elbow 30ga	IMG890ELB30	\$14.87
3" GV End Cap (Big End)30ga	IMG3EC30	\$12.21
4" GV End Cap (Big End)30ga	IMG4EC30	\$12.27
5" GV End Cap (Big End)30ga	IMG5EC30	\$12.41
6" GV End Cap (Big End)28ga	IMG6EC28	\$13.33
6" GV End Cap (Big End)30ga	IMG6EC30	\$12.67
7" GV End Cap (Big End)28ga	IMG7EC28	\$13.66
8" GV End Cap (Big End)28ga	IMG8EC28	\$15.44
4" - 3" GV Inc/Red NC 26ga	IMG43R/126	\$13.84
5" - 3" GV Inc/Red NC 26ga	IMG53R/126	\$13.92
5" - 4" GV Inc/Red NC 26ga	IMG54R/126	\$15.31
6" - 4" GV Inc/Red NC 26ga	IMG64R/126	\$16.20
6" - 5" GV Inc/Red NC 26ga	IMG65R/126	\$16.34
7" - 6" GV Inc/Red NC 26ga	IMG76R/126	\$17.82
8" - 7" GV Inc/Red NC 26ga	IMG87R/126	\$23.13
3" x 24" GV Pipe 24ga	IMG32424	\$12.59
3" x 24" GV Pipe 26ga	IMG34226	#N/A
4" x 24" GV Pipe 26ga	IMG42426	\$11.57
4" x 24" Pipe 24ga	IMG42424	\$16.81
5" x 24" GV Pipe 24ga	IMG52424	\$19.60
5" x 24" GV Pipe 26ga	IMG52426	\$13.63
6" x 24" GV Pipe 24ga	IMG62424	\$21.92
6" x 24" GV Pipe 26ga	IMG62426	\$15.89
7" x 24" GV Pipe 24ga	IMG72424	\$25.65
7" x 24" GV Pipe 26ga	IMG72426	\$21.00
8" x 24" GV Pipe 24ga	IMG82424	\$27.26
8" x 24" GV Pipe 26ga	IMG82426	\$23.31
4" - 4" - 4" Gv Tee 26ga	IMG4TEEF26	\$34.05
5" - 5" - 5" GV Tee 26ga	IMG5TEEF26	\$34.33
6" - 6" - 6" GV Tee 26ga	IMG6TEEF26	\$36.81
7" - 7" - 7" GV Tee 26ga	IMG7TEEF26	\$40.92
8" - 8" - 8" GV Tee 26ga	IMG8TEEF26	\$51.34
8" - 8" - 8" GV Tee 28ga	IMG8TEEF28	\$34.86
6" x 12" GV Chimney Thimble	IMG612THIMBLE	\$10.94
8" x 12" GV Chimney Thimble	IMG812THIMBLE	\$12.89
4" - 6" - 4" GV Wye 26ga	IMG464WYE	\$49.29
5" - 5" - 5" GV Wye 26ga	IMG555WYE	\$50.07
6" - 6" - 4" GV Wye 26ga	IMG664WYE	\$62.27
6" - 6" - 5" GV Wye 26ga	IMG665WYE	\$62.27
6" - 6" - 6" GV Wye 26ga	IMG666WYE	\$65.85
7" - 7" - 7" GV Wye 26ga	IMG777WYE	\$70.75
8" - 8" - 8" GV Wye 26ga	IMG888WYE	\$86.28

Smoke Pipes Components

Selkirk Model

DSP Double Wall Black Smoke Pipe

Most commonly used as interior connector pipe. The connector is an important component of a wood burning system because correct size, arrangement and installation improve the performance and safety of a heating system.

FEATURES:

- It has an inner liner of 400 series stainless steel and outer black painted surface made of durable aluminized steel separated by a 1/4" inch air space. This keeps the flue temperatures higher and the outer pipe temperatures cooler
- Double wall construction withstands temperatures up to 1200°F of continuous operation.
- Can be installed with only a 6" clearance to combustibles. (Single wall stovepipe requires 18" clearance to combustibles).
- Listed and Tested to ULC Standard S-641 and UL-103 standards.

INSTALLATION HINTS:

- The 6" and 8" diameters are ID (inside diameter measurements).
- For installed length, remember to subtract 1-3/8" per joint.
- The minimum clearance to combustibles is 6".
- The maximum recommended length of double wall black stovepipe should not exceed 20'. Per the installation instructions, reduce the maximum limit by 10% for every 90° bend or 5% for every 45° bend.
- The orientation of all chimney connector components must be with the crimped end (outer black pipe) pointing up, towards the chimney towards the chimney. Inner pipe, orient with crimped end pointing down into the appliance flue outlet.
- All joints between sections of the chimney connector must be secured with (3) sheet metal screws (supplied) per joint.
- The black surface of the chimney connector may be touched up with high temp flat black stove paint.

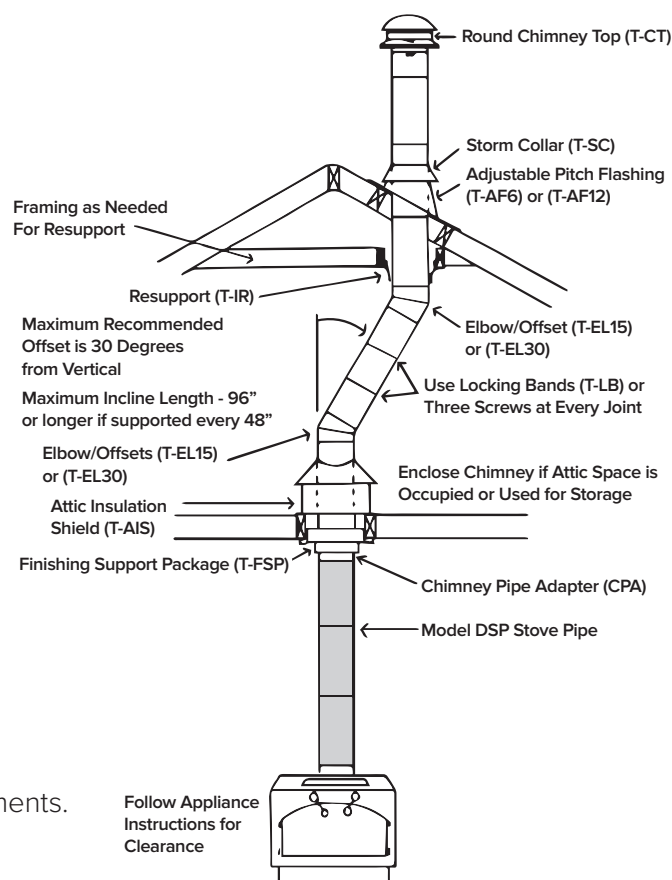

Selkirk Model **DSP Double Wall Pipe**

	6"	8"
Vertical Installation Kit <i>adj from 36"-68"</i> includes: CPA, Telescoping length, Finishing Band	MB6DSPVK \$400.13	MB8DSPVK \$483.57
36" Length	MB6DSP36 \$165.25	MB8DSP36 \$202.42
24" Length	MB6DSP24 \$134.29	MB8DSP24 \$170.49
12" Length	MB6DSP12 \$80.62	MB8DSP12 \$109.07
6" Length	MB6DSP6 \$57.63	MB8DSP6 \$81.16
Adj Length <i>adj from 12"-18"</i> , includes Finishing Band	MB6DSPAL \$110.01	MB8DSPAL \$145.35
90 deg Fixed Elbow	MB6DSP90E \$151.95	MB8DSP90E \$214.98
45 deg Fixed Elbow	MB6DSP45E \$102.45	MB8DSP45E \$141.69
Tee w/End Cap	MB6DSPTE \$136.95	MB8DSPTE \$228.41
Chimney Pipe Adapter	MB6DSPCPA \$63.92	MB8DSPCPA \$76.02
Appliance Adapter	MB6DSPAA \$31.61	MB8DSPAA \$34.45
Masonry Adapter	MB6DSPMA \$77.52	MB8DSPMA \$90.04
Stove Adapter (for stoves w/thick or high collars)	MB6DSPSA \$61.97	MB8DSPSA \$87.50
Flush Stove Adapter (for stoves w/recessed flue outlets)	MB6DSPFSA \$64.09	MB8DSPFSA \$87.50
Damper Kit	MB6DSPDK \$102.45	MB8DSPDK \$153.66
Insulated Wall Thimble	MB6DSPIWT \$483.52	MB8DSPIWT \$562.93
Oval to Round Adapter	Not Available	MB8DSPOTR \$104.76
Finishing Band-Universal (fits 6 and 8" diameters)	MBDSPFB \$17.00	

Smoke Pipe Components

Selkirk Model **DSP Double Wall Pipe**

5" - 6" INCREASER	6" - 7" INCREASER	6" - 8" INCREASER	7" - 8"	8" - 6"
MBDSP156 Large End Crimped \$91.55	MBDSP167 Large End Crimped \$117.46	MBDSP168 Large End Crimped \$155.74	MBDSP178 Large End Crimped \$108.56	MBDSPR86 Large End Crimped \$155.74



**MBDSPFSA
FLUSH STOVE
ADAPTER**



**MBDSPDK
DAMPER KIT**



**MBDSP1WT
INSULATED WALL
THIMBLE**



**MBDSPOTR
OVAL TO ROUND
ADAPTER**



**MBDSPFB
FINISHING
BAND**



**MBDSPVK
VERT. INSTALLATION
KIT**



**MBDSP24
24" LENGTH**



**MBDSPAL
ADJ LENGTH**

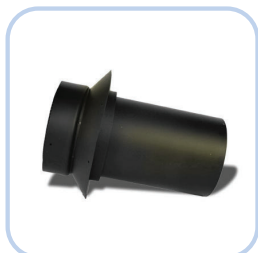

**MBDSPMA
MASONRY
ADAPTER**



**MBDSP90E
90° FIXED
ELBOW**



**MBDSP45E
45° FIXED
ELBOW**



**MBDSPSA
STOVE ADAPTER**



**MBDSPTE
TEE W/END CAP**



**MBDSPCPA
CHIMNEY PIPE ADAPTER**
Used for connection to the Model DSP pipe. (It comes with a finishing sleeve.)

Selkirk Model **Ultra-Temp Class A**



This Multi-Fuel system is ideal for venting residential appliances, burning natural and LP gas, #2 oil, and wood. It's specially designed for today's modern, high efficiency "airtight" wood stoves (solid fuel wood burning fireplaces). Selkirk has a smooth inner liner that produces rapid stabilization for strong draft and heats fast to minimize condensation as waste gases are exhausted. The outer casing carries structural loads leaving the inner pipe free to expand without stress. Tested to 2100° F, a high temperature test option of Underwriters' Laboratories safety standard for factory built chimneys, UL-103 sixth edition. Heavy duty stainless steel is used for all system components. This lightweight pipe has threaded internal couplers that lock together with an 1/8 turn. Locking bands included with every pipe.

1 Masonry Fireplace Using Selkirk Chimney

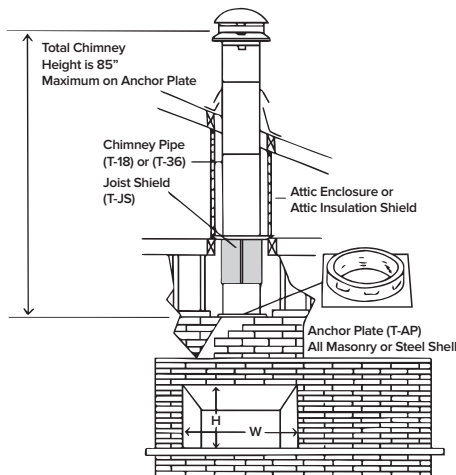

2 Basement Heater with Tee-Supported Outside Chimney

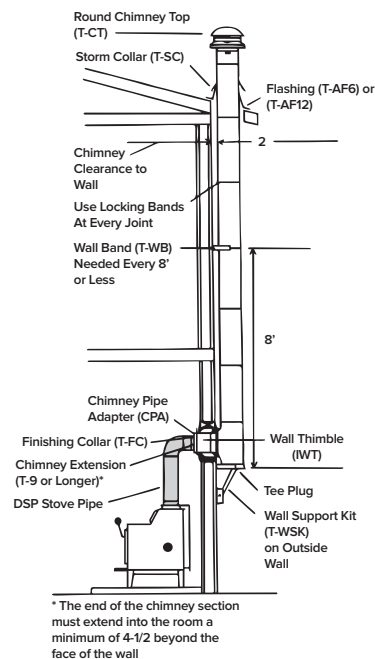

3 Wood Stove with Chimney Offset to Avoid Ridge

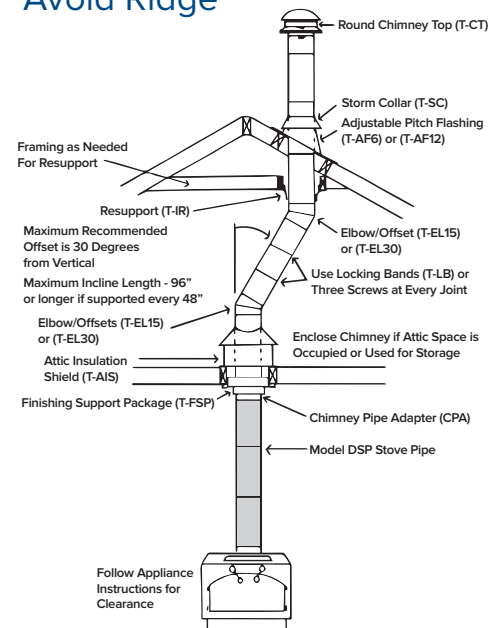

Ultra-Temp Components

④ Solid Fuel Appliance with a Short Vertical Chimney

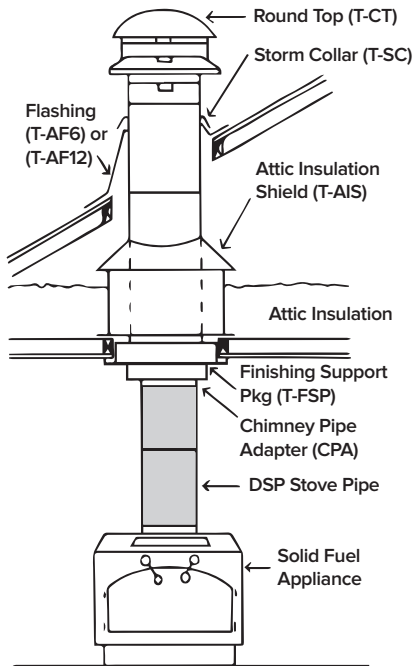

⑤ Combination of Furnace & Water Heater on One Chimney

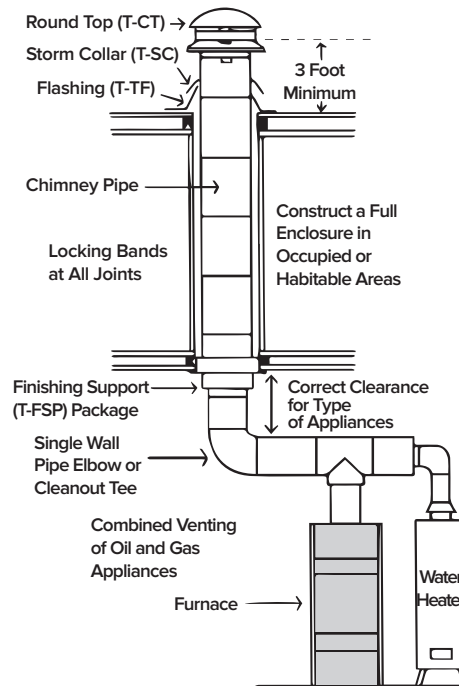

⑥ Wood Heater with its Chimney Through an Upstairs Enclosure

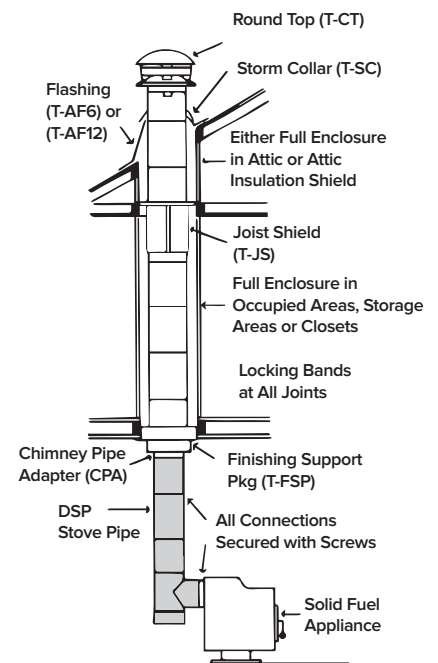

⑦ Pitched Roof with Attic

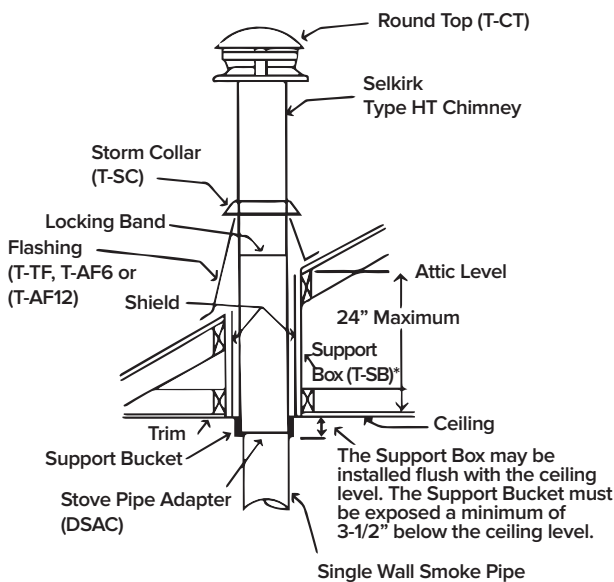

*Support box also intended for use in mobile home A-frame installations.

⑧ A-Frame with Chimney on a Steep Pitch Roof

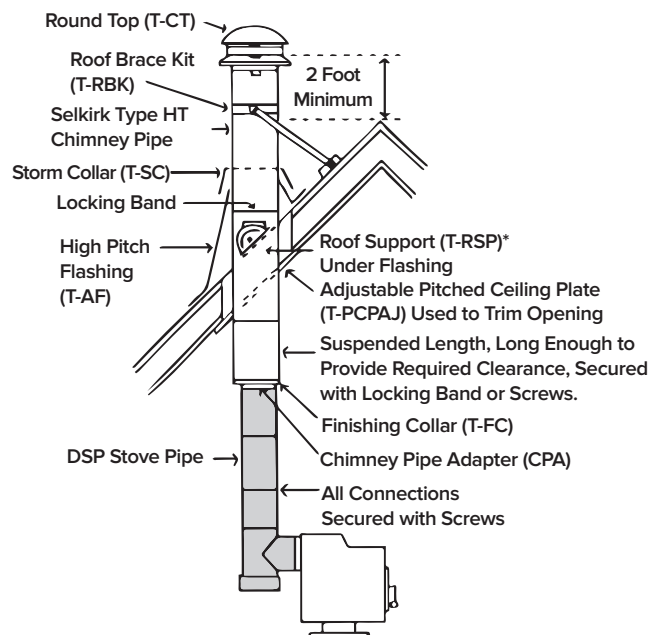

*Support box may also be used. Please consult installation instructions for more information.

Selkirk Model **Ultra-Temp Components**



MB6T48
48" LENGTH



MB6TEL15KIT
15° ELBOW KIT



MB6TIT
TEE W/INSULATED
TEE CAP



MB6TRSP
ROOF SUPPORT
PACKAGE

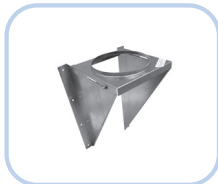

MB6TWSK
WALL SUPPORT
KIT



MBUIRA
UNIVERSAL
INTERIOR
RE-SUPPORT

C	6"	7"	8"
48" Length	MB6T48 \$333.15	MB7T48 \$387.65	MB8T48 \$439.96
36" Length	MB6T36 \$264.31	MB7T36 \$341.02	MB8T36 \$399.55
24" Length	MB6T24 \$191.38	MB7T24 \$246.72	MB8T24 \$291.92
18" Length	MB6T18 \$148.67	MB7T18 \$195.31	MB8T18 \$236.40
12" Length	MB6T12 \$123.42	MB7T12 \$152.01	MB8T12 \$185.01
9" Length	MB6T9 \$117.50	MB7T9 \$144.41	MB8T9 \$174.19
6" Length	MB6T6 \$108.90	MB7T6 \$131.04	MB8T6 \$154.52
15" Elbow Kit Includes: 2 elbows, 2 lock bands, 1 Interior resupport and couplers	MB6TEL15KIT \$396.10	MB7TEL15KIT \$445.98	MB8TEL15KIT \$507.64
30" Elbow Kit Includes: 2 elbows, 2 lock bands, 1 Interior resupport and couplers	MB6TEL30KIT \$577.35	MB7TEL30KIT \$593.26	MB8TEL30KIT \$684.83
Tee w/Insulated Tee Cap	MB6TIT \$373.53	MB7TIT \$490.31	MB8TIT \$552.96
Insulated Tee Cap Only	MB6TIP \$51.43	MB7TIP \$59.88	MB8TIP \$63.31
Roof Support Package Includes: 18" length of pipe, roof brackets, hardware	MB6TRSP \$247.52	MB7TRSP \$279.58	MB8TRSP \$311.87
Universal Wall/Resupport Assy (5"-8") For support above tee, vertical	MBUWRSA \$158.22		
Wall Support Kit Used to support tee, lateral	MB6TWSK \$141.26	MB7TWSK \$175.97	MB8TWSK \$206.07
Finish Support Package (Square Plate)	MB6TFSP \$148.07	MB7TFSP \$177.34	MB8TFSP \$182.56
Flat Ceiling Support Kit Includes: Round top, attic insulation shield, storm collar, square finish support package, adjustable flashing and stove pipe adapter.	MB6TFCK \$654.97	Not Available	MB8TFCK \$883.39
Thru-The-Wall Support Kit Includes: Round top, 12" insulated pipe length, wall band, Insulated tee/plug, finishing collar, wall support kit, chimney pipe adapter, insulated wall thimble.	MB6TTWK \$1,054.02	Not Available	MB8TTWK \$1,535.28

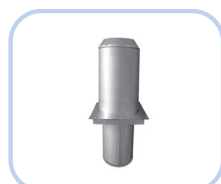

MB6TAIS
ATTIC
INSULATION
SHIELD

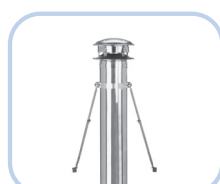

MBURBK
UNIVERSAL
ROOF
BRACE KIT



MB6TFCK
FLAT CEILING
SUPPORT KIT



MB6TTWK
THRU-THE-WALL
SUPPORT KIT

Pellet Vent Components

C	6"	7"	8"
Finish Support Package (Round Plate)	MB6TFSPR \$171.25	Not Available	MB8TFSPR \$208.31
Universal Interior Resupport (5"- 8")	MBUIRA \$98.70		
Support Box Cathedral Ceiling	MB6TSB \$222.12	MB7TSB \$231.12	MB8TSB \$242.68
Adj. Smoke Pipe Adapter	MB6TDSA \$88.04	MB7TDSA \$95.32	MB8TDSA \$99.87
Dripless Smoke Pipe Adapter w/Coupler	MB6TDSAC \$110.45	MB7TDSAC \$121.13	MB8TDSAC \$123.70
Attic Insulation Shield	MB6TAIS \$114.16	MB7TAIS \$123.65	MB8TAIS \$152.20
Universal Roof Brace Kit (5"- 14") Includes: Support band, adjustable tube, bolt adjustment, roof bracket	MBURBK \$144.24		
Roof Support Kit Includes: Brackets and mounting hardware only (does not include pipe or band)	MBSRK \$98.70		
Universal Roof Support Kit Includes: Brackets, mounting hardware with band	MBURSA \$113.12		
Locking Band	MB6TLB \$18.51	MB7TLB \$20.33	MB8TLB \$21.65
Wall Band	MB6TWB \$49.53	MB7TWB \$58.03	MB8TWB \$63.53
Anchor Plate	MB6TAP \$92.58	MB7TAP \$115.32	MB8TAP \$125.90
Finishing Collar	MB6TFC \$28.02	MB7TFC \$33.84	MB8TFC \$38.66
Fire Stop/Trim Collar w/Spacer	MB6TTPS \$61.94	MB7TTPS \$75.22	MB8TTPS \$89.08
Pitched Ceiling Plate (0/12-12/12)	MB6TPCPAJ \$57.09	MB7TPCPAJ \$66.54	MB8TPCPAJ \$72.29

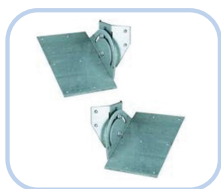

MBSRK
ROOF SUPPORT KIT
Brackets and mounting hardware only



MB6TLB
LOCKING BAND



MB6TWB
WALL BAND



MB6TFC
FINISHING COLLAR



MBTTPS
TRIMPLATE SPACER
(use w/Firestop)

CHIMNEY COMPONENTS

C	6"	7"	8"
Universal Spark Arrestor	MB6TUSA \$37.90	MB7TUSA \$47.42	MB8TUSA \$48.18
Fire Stop/Joist Shield	MB6TJS \$45.19	MB7TJS \$53.48	MB8TJS \$80.04
Insulated Wall Thimble	MB6TIWT \$113.12	MB7TIWT \$123.42	MB8TIWT \$133.68
Round Top	MB6TCT \$126.64	MB7TCT \$172.79	MB8TCT \$232.11
Storm Collar	MB56TSC \$20.46	MB78TSC \$23.20	
Flat Tall Cone Roof Flashing 0/12-2/12	MB6TTF \$153.80	MB7TTF \$179.12	MB8TTF \$188.73
Adj. Roof Flashing 2/12-6/12	MB6TAF6 \$114.89	MB7TAF6 \$131.70	MB8TAF6 \$144.26
Adj. Roof Flashing 6/12-12/12	MB6TAF12 \$150.41	MB7TAF12 \$172.38	MB8TAF12 \$186.99
Adj. Roof Flashing 12/12-24/12	MB6TAF24 \$302.82	MB7TAF24 \$342.52	MB8TAF24 \$376.20
Adj. Roof Flashing 24/12-36/12	MB6TAF36 \$432.43	MB7TAF36 \$488.70	MB8TAF36 \$508.56
Universal Metal Roof Flashing Kit (Flashing Sold Separate)	MBUMRFK \$45.29		
Universal Rubber Boot Flashing Adapter	MBURBAK \$325.20		
Pitched Ceiling Support Kit (includes: CT, SC, FC, RSP, DSAC, and PCPAJ)	MB6TPCK \$530.29	Not Available	MB8TPCK \$717.21

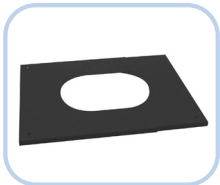

**MB6TPCPAJ
PITCHED CEILING
PLATE**

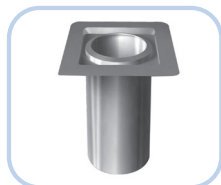

**MB6TJS
FIRE STOP/
JOIST SHIELD**

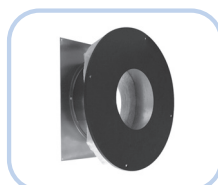

**MB6TIWT
INSULATED
WALL THIMBLE**

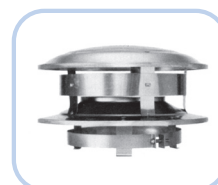

**MB6TCT
ROUND TOP**

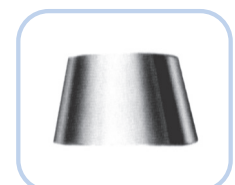

**MB6TSC
STORM COLLAR**

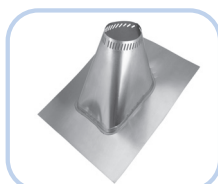

**MB6TAF6
ADJUSTABLE
ROOF FLASHING**

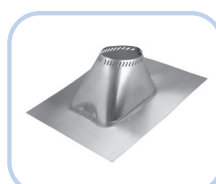

**MB6TAF12
ADJUSTABLE
ROOF FLASHING**

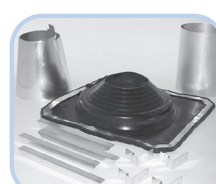

**MBURBAK
UNIVERSAL
RUBBER BOOT
FLASHING
ADAPTER**



**MB6TPCK
PITCHED CEILING
SUPPORT KIT**

Venting Components & Pipe Accessories

Description	Part Number	
Pipe Length 3" ID X 6	UPP36	\$31.02
Pipe Length 3" ID X 6, Black	UPP36B	\$43.61
Pipe Length 3" ID X 12	UPP312	\$60.36
Pipe Length 3" ID X 12, Black	UPP312B	\$53.21
Pipe Length 3" ID X 18	UPP318	\$51.36
Pipe Length 3" ID X 18, Black	UPP318B	\$58.26
Pipe Length 3" ID X 24	UPP324	\$58.64
Pipe Length 3" ID X 24, Black	UPP324B	\$66.43
Pipe Length 3" ID X 36	UPP336	\$80.40
Pipe Length 3" ID X 36, Black	UPP336B	\$91.00
Pipe Length 3" ID X 60	UPP360	\$114.99
Pipe Length 3" ID X 60, Black	UPP360B	\$136.26

Description	Part Number	
Adjustable Length 3" ID X 12	UPP312	\$60.36
Adjustable Length 3" ID X 12, Black	UPP312AB	\$66.05

Description	Part Number	
45 Degree Elbow 3" ID	UPP345E	\$78.44
45 Degree Elbow 3" ID - Black	UPP345EB	\$87.45
90 Degree Elbow 3" ID	UPP390E	\$90.50
90 Degree Elbow 3" ID - Black	UPP390EB	\$95.40

Description	Part Number	
Tee w/Tee Cap 3" ID	UPP3T	\$131.41
Tee w/ Tee Cap 3" ID , Black	UPP3TB	\$142.79
Tee w/Tee Cap w/ Appliance Adapter 3" ID	UPP3TA	\$131.41
Tee w/Tee Cap w/ Appliance Adapter 3" ID , BLK	UPP3TAB	\$142.79
Increaser Tee w/ Tee Cap 3" ID	UPP3IT	\$133.77
Increaser Tee w/ Tee Cap 3" ID , Black	UPP3ITB	\$150.02
Double Tee w/ Tee Cap 3" ID	UPP3DT	\$220.90
Double Tee w/ Tee Cap 3" ID , Black	UPP3DTB	\$226.89
Tee Cap 3" ID	UPP3TC	\$25.69
Tee Cap 3" ID , Black	UPP3TCB	\$32.72

Description	Part Number	
Vertical Termination Cap - 3" ID	UPP3VC	\$72.90
Horizontal Termination Cap - 3" ID	UPP3HC	\$64.52
Screen Cap - 3" ID (45 degree elbow sold seperately)	UPP345T	\$50.08

Description	Part Number	
Ceiling Support 3" ID , Black	UPP3CSB	\$64.22
Firestop Ceiling Support 3" ID	UPP3FCS	\$49.78
Cathedral Ceiling Support 3" ID , Black	UPP3CCS	\$133.06
Wall Thimble 3" ID , Black	UPP3WTB	\$83.79



**MB6TLB
LOCKING BAND**



**UPP3HC
HORIZONTAL
TERMINATION**



**UPP36
ULTIMATE
PELLETPipe**



**UPP312
ULTIMATE
PELLETPipe
ADJUSTABLE
LENGTH**



**UPP345E
45 DEGREE
ELBOW**



**UPP390E
90 DEGREE
ELBOW**

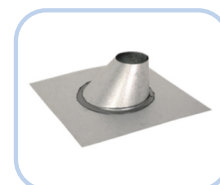

**UPP3F6
ADJUSTABLE
FLASHING**



**UPP3WB
ADJUSTABLE
WALL BAND**



**UPP3AA
APPLIANCE
ADAPTER**



**UPP3AIS
ATTIC
INSULATION
SHIELD**

CHIMNEY COMPONENTS

Description	Part Number	
Adjustable Wall Band 3" ID	UPP3WB	\$30.01
Firestop 3" ID	UPP3FS	\$31.19
Attic Insulation Shield 3" ID	UPP3AIS	\$67.58
Trim Plate 3" ID , Black	UPP3TP	\$37.42

Description	Part Number	
Increaser 3" to 4"	UPP3I4	\$88.13
Increaser 3" to 4", Black	UPP3I4-B	\$100.53
Vacuum Cleanout Cap 3" ID	UPP3VCC	\$37.42

Description	Part Number	
Appliance Adapter 3" ID	UPP3AA	\$24.16
Appliance Adapter 3" ID , Black	UPP3AAB	\$36.20
Masonry Adapter 3" ID	UPP3MA	\$53.15
Harman Pipe Adapter - Outside	UPP3HAA1	\$30.16
Harman Pipe Adapter - Inside	UPP3HAA2	\$27.70
Chimney Adapter 3" ID - 6" Chimney	UPP3CA6	\$97.86
Chimney Adapter 3" ID - 8" Chimney	UPP3CA8	\$103.95

Description	Part Number	
Tall Cone Flashing 3" ID	UPP3TF	\$33.51
Adjustable Flashing 1/12-6/12 3" ID	UPP3F6	\$25.13
Adjustable Flashing 6/12-12/12 3" ID	UPP3F12	\$37.42
Storm Collar 3" ID	UPP3SC	\$7.23

Description	Part Number	
Thru The Wall KIT 3" ID	UPP3TWK	\$642.63

Description	Part Number	
Pipe Length 4" ID X 6	UPP46	\$33.20
Pipe Length 4" ID X 6, Black	UPP46B	\$54.12
Pipe Length 4" ID X 12	UPP412	\$47.45
Pipe Length 4" ID X 12, Black	UPP412B	\$61.69
Pipe Length 4" ID X 18	UPP418	\$63.61
Pipe Length 4" ID X 18, Black	UPP418B	\$69.78
Pipe Length 4" ID X 24	UPP424	\$74.07
Pipe Length 4" ID X 24, Black	UPP424B	\$83.18
Pipe Length 4" ID X 36	UPP436	\$96.18
Pipe Length 4" ID X 36, Black	UPP436B	\$102.99
Pipe Length 4" ID X 60	UPP460	\$130.38
Pipe Length 4" ID X 60, Black	UPP460B	\$157.05

Description	Part Number	
Adjustable Length 4" ID X 12	UPP412A	\$66.71
Adjustable Length 4" ID X 12, Black	UPP412AB	\$74.66



**UPP4BK
BASEMENT KIT**



**UPP3CCS
CATHEDRAL
CEILING
SUPPORT**

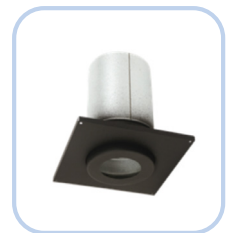

**UPP3CSB
CEILING
SUPPORT**



**UPP2CA6
CHIMNEY
ADAPTER**



**UPP3DT
DOUBLE TEE
WITH
TEE CAP**

INSULATED WALL THIMBLE

Installs quickly and eliminates the need for using individual fire stops. The round shielding acts as a radiation shield and provides the required 2" air space clearance to combustibles. The two sections telescope to accommodate 6" to 11" wall thickness.

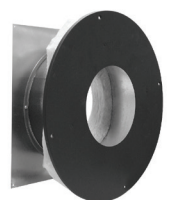

Venting Components & Pipe Accessories

Description	Part Number	
45 Degree Elbow 4" ID	UPP445E	\$88.87
45 Degree Elbow 4" ID - Black	UPP445EB	\$99.25
90 Degree Elbow 4" ID	UPP490E	\$97.86

Description	Part Number	
Tee w/Tee Cap 4" ID	UPP4T	\$137.41
Tee w/Tee Cap 4" ID , Black	UPP4TB	\$37.42
Tee w/Tee Cap w/ Appliance Adapter 4" ID	UPP4TA	\$137.41
Tee w/Tee Cap w/ Appliance Adapter 4" ID , BLK	UPP4TAB	\$152.16
Double Tee w/ Tee Cap 4" ID	UPP4DT	\$238.51
Double Tee w/ Tee Cap 4" ID , Black	UPP4DTB	\$244.63
Tee Cap 4" ID	UPP4TC	\$26.85
Tee Cap 4" ID , Black	UPP4TCB	\$33.41

Description	Part Number	
Vertical Termination Cap - 4" ID	UPP4VC	\$77.80
Horizontal Termination Cap - 4" ID	UPP4HC	\$70.59
Screen Cap - 4" ID (45 degree elbow sold seperately)	UPP445T	\$60.72

Description	Part Number	
Ceiling Support 4" ID , Black	UPP4CSB	\$74.91
Firestop Ceiling Support 4" ID	UPP4FCS	\$52.59
Cathedral Ceiling Support 4" ID , Black	UPP4CCS	\$133.06
Wall Thimble 4" ID , Black	UPP4WTB	\$90.02

Description	Part Number	
Adjustable Wall Band 4" ID	UPP4WB	\$32.54
Firestop 4" ID	UPP4FS	\$41.55
Attic Insulation Shield 4" ID	UPP4AIS	\$67.58
Trim Plate 4" ID , Black	UPP4TB	\$37.42
Vacuum Cleanout Cap 4" ID	UPP4VCC	\$43.97

Description	Part Number	
Appliance Adapter 4" ID	UPP4AA	\$26.17
Appliance Adapter 4" ID , Black	UPP4	\$39.19
Masonry Adapter 4" ID	UPP4MA	\$53.15
DT Adapter 4" ID	UPP4DTA	\$89.56
Flex Connector 4"	UPP4FC	\$25.13
Reverse Flex Connector 4"	UPP4FCR	\$25.13
Chimney Adapter 4" ID - 6" Chimney	UPP4CA6	\$97.86
Chimney Adapter 4" ID - 8" Chimney	UPP4CA8	\$103.95
Multi-Fit Connector 3" TO 4"	UPP4MFC	\$70.55

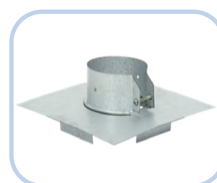

UPP3FCS
FIRESTOP
CEILING SUPPORT

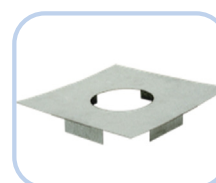

UPP3FCS
FIRESTOP



UPPGT
GREASE TUBE



UPP3HAA1
HARMAN PIPE
ADAPTER



UPP4DTA
DT ADAPTER



UPP4MA
MASONRY
ADAPTER



UPP4FC
FLEX CONNECTOR



UPP4SC
STORM COLLAR

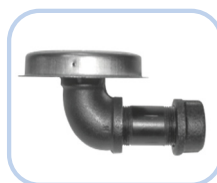

UPP4VSS
VACUUM
CLEAN-OUT CAP

CHIMNEY COMPONENTS

Description	Part Number	
Tall Cone Flashing 4" ID	UPP4TF	\$37.06
Adjustable Flashing 1/12-6/12 4" ID	UPP4F6	\$28.02
Adjustable Flashing 6/12-12/12 4" ID	UPP4F12	\$42.44
Storm Collar 4" ID	UPP4SC	\$8.38

Description	Part Number	
Thru The Wall KIT 4" ID	UPP4TWK	\$887.82
Basement KIT 4" ID	UPP4BK	\$1,164.50
Insert Flex Kit 4" ID X 25' Length	UPP4IK25	\$894.60
Insert Flex Kit 4" ID X 35' Length	UPP4IK35	\$997.19

Description	Part Number	
Single Use Grease Packet	UPPSGP	\$25.87
5 oz. Grease Tube	UPPGT	\$0.95
UPP Sample Kit	UPPSK	\$80.13

FIRESTOP/JOIST SHIELD

Used in floor/ceiling penetrations other than those which include a ceiling support. Not required when passing through the roof.



DRIPLESS SMOKE PIPE ADAPTERS

Used to connect single wall pipe to Ultra-Temp Selkirk insulated chimney pipe. It's designed to slip inside the single wall stove pipe to contain any creosote dripping down the chimney to the inside of the pipe system. Choose the DSA for use in retrofit installations and the DSAC (includes coupler) for use in new installations.

DSA



DSAC



UPP3TC
TEE CAP

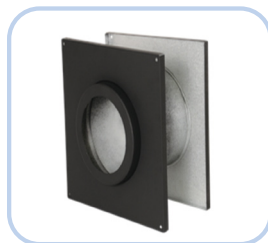

UPP4WTB
WALL THIMBLE



UPP4VC
VERTICAL
TERMINATION CAP



UPP4TWK
THROUGH-THE-WALL KIT



UPP4FCR
REVERSE FLEX CONNECTOR



UPP4IK35
INSERT FLEX KIT

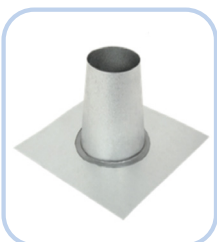

UPP4TF
TALL CONE
FLASHING



UPP4445T
SCREEN CAP

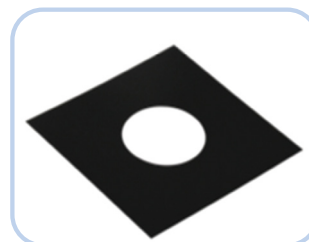

UPP3TP
TRIM PLATE



UPP3T
TEE WITH TEE
CAP



UPP3IT
INCREASER TEE
WITH TEE CAP

Multi-Flue Caps

Premier Top Mount Multi-Flue Caps



Premier Multi-Flue Caps are available in virtually all lengths and widths and four standard heights: 8", 10", 12", and 16". Our most popular sizes have special, discounted pricing which is already calculated in the table below. Note: The lid extends 3" beyond the side of the cap. So for example, a 9" x 9" cap would have a lid that is 15" x 15".



If you don't see your size listed, please call us at **800-897-8481**.

**Custom Sized PT Caps do not qualify for free shipping.*

PT91310	\$118.72
PT91312	\$126.14
PT9910	\$103.88
PT9912	\$111.30
PT131310	\$113.53
PT131312	\$119.83
PT131710	\$126.14
PT131712	\$132.45
PT132110	\$138.75
PT132112	\$145.06
PT132510	\$151.37
PT132512	\$157.68
PT132910	\$163.98
PT132912	\$170.29
PT133310	\$207.76
PT133312	\$215.18
PT133710	\$222.60
PT133712	\$246.45
PT141410	\$119.83
PT141412	\$126.14

PT171710	\$138.75
PT171712	\$170.66
PT172110	\$151.37
PT172112	\$157.68
PT172510	\$163.98
PT172512	\$170.29
PT172910	\$176.60
PT172912	\$182.90
PT173310	\$189.21
PT173312	\$209.49
PT173510	\$209.49
PT173512	\$216.24
PT173710	\$216.24
PT173712	\$223.00
PT174110	\$229.76
PT174112	\$236.52
PT174510	\$305.28
PT174512	\$313.76
PT174910	\$273.90
PT174912	\$281.11

PT175310	\$288.32
PT175312	\$347.68
PT175710	\$302.74
PT175712	\$364.64
PT212110	\$192.92
PT212112	\$200.34
PT212510	\$176.60
PT212910	\$189.21
PT212912	\$209.49
PT213310	\$216.24
PT213312	\$223.00
PT213710	\$270.30
PT213712	\$278.25
PT214110	\$305.28
PT214112	\$313.76
PT214510	\$322.24
PT214512	\$281.11
PT214910	\$339.20
PT214912	\$347.68

CUSTOM SIZED TOP MOUNT CAPS AVAILABLE. ALL SIZES AVAILABLE.

CUSTOM WORKSHEETS ON PAGE 134

Add Length + Width + Height and multiply the result by the Multiplier below				
Total Inches (L+W+H)	0-60"	61"-70"	71"-100"	101"+
Multiplier	3.5	3.75	4	Custom

Our Multi-Flue Caps have a top mount design that attaches easily to the top of the chimney crown or brick with chimney top adhesive and tapcons (included with each cap). All caps have a hinged mounting system to provide extra space when the fit is tight. Note: Caps wider than 33" require a lid support—provided by National Chimney.

The multi-flue cap has a top mount design that easily attaches to the top of the chimney crown or brick with chimney top adhesive and tapcons (included with each cap). All Premier Top Mount Multi-Flue Caps have a hinged mounting system that gives extra space for a tight fit.



TAPCONS 1/4 X 1 1/4 (100/PKG)
FAPTTAPCON: \$36.17



Top Mount-Flue Cap Design



All caps come with 3/4" mesh to keep sparks in and critters out.



The 4 bolts and serrated flange locknuts (nut/washer combo) hold the sides together and the lid in place.



Caps have top bolts on the top and screen ends that attach to the screen box.

Premier Top Multi-Flue Caps are available in all sizes.
If you do not see the size you need, please call us at 800-897-8481.

Custom Flue Caps

Stainless Steel Mesh for Caps Replacement

Custom lengths & widths
Call for pricing.

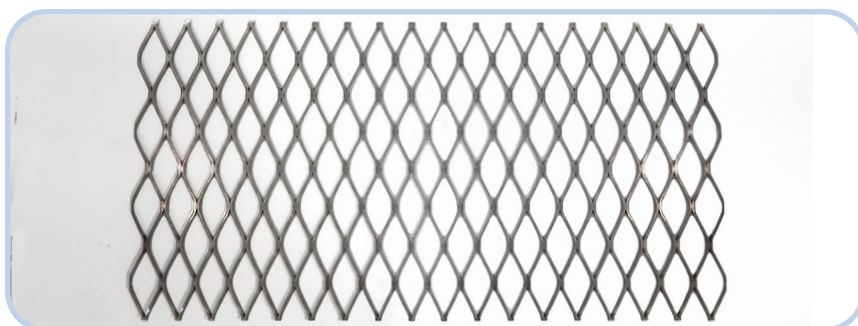

Hip & Ridge Caps

Hip and Ridge Caps are made from 24ga 304 stainless steel. They are available in knock-down style or pre-assembled. Hip and Ridge Caps come with a 4" overhang on all four sides and a hinge flange on the bottom. They are designed with the lid secured to the frame from underneath which results in a leak proof lid.

Powder coating and copper are available upon request. Please call 800-897-8481.



Pitched Skirt Style Multi-Flue Caps

Pitched Skirt Style Multi-Flue Caps are made from 24ga 304 stainless steel with a removable lid. The lid extends beyond the sides of the skirt. The standard skirt size is 3" and the pitched section on top is 2" long. All custom sizes and heights are available between 9" - 33" wide and 9" - 84" long.

Powder coating is available upon request.
Please call 800-897-8481 .



Premier Stackable Single Flue Caps (4 Pack)

- Highly Durable Sizes ranging from 9" x 9" to 18" x 18"
- Designed for Single Flue Masonry Chimneys
- Works for Wood, Pellet, Oil, Gas, and All Other Fuels
- 304-Alloy Stainless Steel Construction with 3/4" rust resistant Mesh
- Base & Mesh are 18-gauge; Lid is 24-gauge
- Single-Piece Base and Screen Frame—for added strength
- Heavy-Duty Screen—keeps out critters and debris
- Easy to Assemble and Install
- Removable Lid with Open Screen Frame—makes for easy access and maintenance
- Attaches directly to the chimney's flue tile—to protect both the flue and crown
- Lifetime Warranty

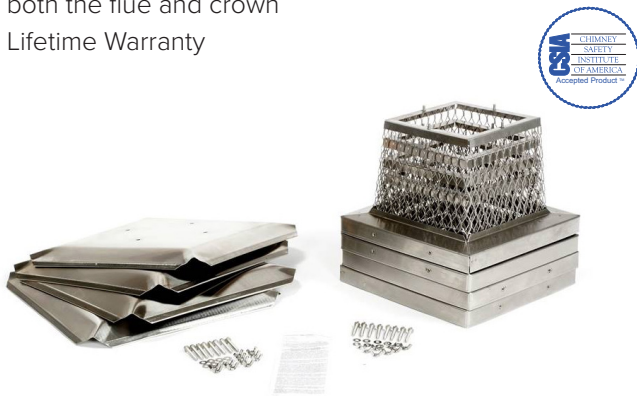

C FITS OUTSIDE TILE DIMENSIONS		
9" x 9"	7.5"x7.5" to 9.5"x9.5"	NCFP99 \$195.88
9" x 13"	7.5"x11.5" to 9.5"x13.5"	NCFP913 \$265.84
9" x 18"	7.5"x16.5" to 9.25"x18.25"	NCFP918 \$311.00
12" x 12"	10.5"x10.5" to 12.5"x12.5"	NCFP1212 \$297.00
13" x 13"	11.5"x11.5" to 13.5"x13.5"	NCFP1313 \$313.54
13" x 18"	11.5"x16.5" to 13.25"x18.25"	NCFP1318 \$325.00
18" x 18"	16.5"x16.5" to 18.25"x18.25"	NCFP1818 \$375.24

HARDWARE PACK (4 CAPS)
NCFPHW: \$16.45

Powder Coated Caps

Powder coating available. Call for pricing.

Due to the recommended 6" minimum clearance necessary for proper drafting from the highest protrusion (i.e. top of flue tile, liner or chimney) to the cap lid, there are several heights to choose from. For example: Flue tile extends up 6" from the crown of the chimney. To calculate the required clearance, add 6" to get a mesh or screen height of 12" needed. Another recommendation to gain the required clearance is to cut down the flue tiles using a disc grinder.

**Custom Sized PT Caps do not qualify for free shipping.*



Custom Caps

Custom Caps available. Call for pricing.



Flue Caps

HY-C Universal Covers

These covers fit 95% of masonry flue tiles. They are available with 3/4" mesh and 5/8" mesh to meet California code. The secure inside anchoring system is ideal for windy conditions. Available in both black and stainless, adjustable so one size cover is able to fit several flue sizes, reducing sizes needed on hand. The 13" x 13" cover will fit flues from 7" x 7" to 13 1/2" x 13 1/2" and will work on square, round or rectangle flues. The 13" x 20" cover will fit rectangular flues from 7" x 14" to 13" x 20 1/2" and 13" x 13" square. All covers are 304 stainless steel and will work on extended flues or flues that are flush.



C Screen to Screen	Mesh	Color	Product Number
13" x 13"	5/8" mesh	Black	HYCU1313B58 \$59.99
	5/8" mesh	Stainless Steel	HYCU1313S58 \$139.19
	3/4" mesh	Black	HYCU1313B34 \$56.39
	3/4" mesh	Stainless Steel	HYCU1313S34 \$136.79
13" x 20 1/2"	5/8" mesh	Black	HYCU1320B58 \$67.19
	5/8" mesh	Stainless Steel	HYCU1320S58 \$150.59
	3/4" mesh	Black	HYCU1320B34 \$63.59
	3/4" mesh	Stainless Steel	HYCU1320S34 \$148.19

WHY CUSTOMERS LOVE NATIONAL CHIMNEY

“

I have been installing National Chimney Supply's manufactured products for over 25 years. It's not just a high quality product that sets National Chimney above the rest, it's the whole package. Reaching out to customer service to place an order and you KNOW you and your business are in the right hands for success. They hand it off to skilled craftsman that manufacture the highest quality products in the industry. **Orders filled to ship are loaded with care by some of the best in the business that never overlook any detail.** The delivery team communicates and takes great care getting the product to your doorstep. **Let's not forget the endless sponsorships and educational opportunities National Chimney serves up for us all on a regular basis! All one cohesive machine working towards your success in the chimney industry.**

- Dana M. Storrs, *DM Storrs Chimney LLC*



Flue Caps



HY-C Single Universal Flue Caps

Constructed of 18ga 304 Stainless Steel with a 8" high $\frac{3}{4}$ " expanded stainless steel mesh ($\frac{5}{8}$ " mesh also available). These caps mount to the outside of the flue tile providing greater free air space for better draft. HY-C leg kits attach cap to the inside of the flue if your flue tile doesn't extend above the crown.

C	FITS OUTSIDE TILE DIMENSIONS	STAINLESS	STAINLESS PAINTED BLACK	GALVANIZED BLACK	COPPER
9" x 9"	7 1/2" x 7 1/2" to 9 1/2" x 9 1/2"	SS99 \$76.43	SS99PB \$88.79	CBO99 \$48.59	CU99 \$366.47
9" x 13"	7 1/2" x 11 1/2" to 9 1/2" x 13 1/2"	SS913 \$88.13	SS913PB \$100.37	CBO913 \$50.21	CU913 \$380.09
9" x 18"	7 1/2" x 16 1/2" to 9 1/4" x 18 1/4"	SS918 \$111.59	SS918PB \$123.71	CBO918 \$53.46	CU918 \$392.93
11" x 11"	9 3/4" x 9 3/4" to 12" x 12"	SS1111 \$97.89	SS1111PB \$112.07	CBO1111 \$51.83	Not Available
13" x 13"	11 1/2" x 11 1/2" to 13 1/2" x 13 1/2"	SS1313 \$123.35	SS1313PB \$135.41	CBO1313 \$54.53	CU1313 \$405.77
15" x 15"	13 3/4" x 13 3/4" to 16" x 16"	SS1515 \$146.87	SS1515PB \$158.75	CBO1515 \$64.25	Not Available
13" x 18"	11 1/2" x 16 1/2" to 13 1/4" x 18 1/4"	SS1318 \$158.63	SS1318PB \$170.39	CBO1318 \$69.11	CU1318 \$432.23
18" x 18"	16 1/2" x 16 1/2" to 18" x 18"	SS1818 \$170.39	SS1818PB \$182.03	CBO1818 \$73.97	CU1818 \$445.91
20" x 20"	18 1/2" x 18 1/2" to 20 1/4" x 20 1/4"	SS2020 \$182.15	SS2020PB \$193.67	CBO2020 \$78.83	Not Available

C	FITS OUTSIDE TILE DIMENSIONS	STAINLESS
9" x 9" - 4 Pack	7 1/2" x 7 1/2" to 9 1/2" x 9 1/2"	SSFP99 \$351.64
9" x 13" - 4 Pack	7 1/2" x 11 1/2" to 9 1/2" x 13 1/2"	SSFP913 \$367.89
13" x 13" - 4 Pack	11 1/2" x 11 1/2" to 13 1/2" x 13 1/2"	SSFP1313 \$416.64



HY-C Round Single Flue Caps

Stainless steel single flue cap has welded on legs. It is also available in stainless steel black painted and black painted galvanized, special order. **Call for quote.**

C Outside Tile Size (Slip In)	10"	12"	14"
Fits Outside Tile Dimension (in inches)	9 1/2" to 10 1/2" Rd	11 1/2" to 12 1/2" Rd	13 1/2" to 14 1/2" Rd
Stainless Steel	SS811 \$119.39	SS813 \$130.61	SS815 \$141.83



HY-C ShelterPro Single Flue Caps

Constructed of 24ga 304 stainless steel with 3/4" mesh. HY-C ShelterPRO caps have a smaller lid than traditional HY-C Single Flue caps making it easier to install caps side by side.

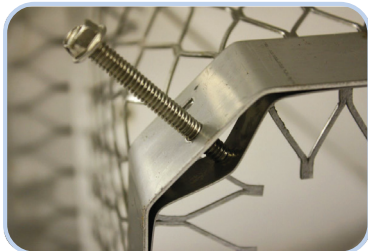

C	FITS OUTSIDE TILE DIMENSIONS	STAINLESS
9" x 9"	7 1/2" x 7 1/2" to 9 1/2" x 9 1/2"	SPSS99 \$68.15
9" x 13"	7 1/2" x 11 1/2" to 9 1/2" x 13 1/2"	SPSS913 \$75.71
9" x 18"	7 1/2" x 16 1/2" to 9 1/4" x 18 1/4"	SPSS918 \$84.11
13" x 13"	11 1/2" x 11 1/2" to 13 1/2" x 13 1/2"	SPSS1313 \$93.47
13" x 18"	11 1/2" x 11 1/2" to 13 1/4" x 18 1/4"	SPSS1318 \$102.83
18" x 18"	16 1/2" x 16 1/2" to 18" x 18"	SPSS1818 \$113.09

HY-C Leg Kits

Stainless steel legs to adapt any single flue cap to a slide-in style.



**STAINLESS STEEL
HLKS: \$13.19**

**SHELTERPRO
SCLK: \$7.19**

Cap Mounting Brackets

Use these stainless steel brackets to mount your single flue cap to the crown of the chimney. Simply attach with tapcons through the pre-drilled holes in the bracket.

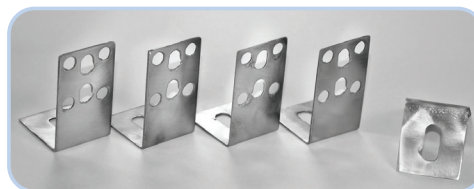

**12/PKG CAP
MOUNTING
BRACKETS
NCCMBB: \$26.79**

Dampers

Raccoon Screens

This heavy-duty animal control screen is built to prevent access to the chimney from even the most bothersome animal pests such as raccoons or opossums. Its tamper-proof bolt-on attachment method makes it impossible for pests to remove and gain access.



C	FITS OUTSIDE TILE DIMENSIONS	GALV. PAINTED BLACK	STAINLESS
9" x 9"	7 1/2" x 7 1/2" to 9 1/2" x 9 1/2"	SSRC99 \$46.79	SSRS99 \$84.71
9" x 13"	7 1/2" x 11 1/2" to 9 1/2" x 13 1/2"	SSRC913 \$54.35	SSRS913 \$97.19
13" x 13"	11 1/2" x 11 1/2" to 13 1/2" x 13 1/2"	SSRC1313 \$56.81	SSRS1313 \$112.97

Deflecto Universal Bird & Rodent Guard

The patented universal bird guard keeps unwanted birds and other animals from nesting or entering the home thru the dryer vent. The bird guard also installs over bathroom exhaust vents and is easy to install on 3" or 4" hoods.



BROWN BIRD GUARD
DUBGBB: \$5.21



WHITE BIRD GUARD
DUBGWB: \$5.07

Damper Adapter Plate

This adapter is used for the Insulated Premier Damper Cap (shown on next page) to allow for installation on a flat surface.

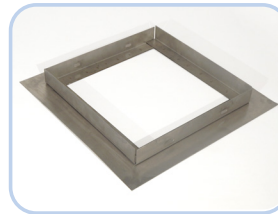

INSTALL KIT
NATHDWBAG: \$30.17

NOTE: Hardware pack includes a 50' cable

PDC99AP	PDC913AP	PDC1212AP	PDC1313AP	PDC1216AP	PDC1616AP	PDC1318AP	PDC1818AP
\$54.04	\$61.90	\$69.79	\$69.79	\$76.10	\$82.39	\$82.39	\$92.96

Premier Flat Base Damper Cap



This Flat Style Damper is designed to be mortared into the crown or fit directly onto an existing top plate. The base plate is made from 18ga 304 stainless steel, and the plate extends 2' past the screen for ease of installation.



C Size	9" x 9"	9" x 13"	12" x 12"	12" x 16"	13" x 13"	13" x 18"	16" x 16"	18" x 18"
Tile Sizes O.D.	8" x 8" 9" x 9" 10" x 10"	8" x 12" 9" x 13" 10" x 14"	11" x 11" 12" x 12"	11" x 15" 12" x 16" 13" x 17"	13" x 13" 14" x 14"	12" x 17" 13" x 18" 14" x 19"	15" x 15" 16" x 16" 17" x 17"	17" x 17" 18" x 18" 19" x 19"
Base opening	10½" x 10½"	10½" x 14½"	13½" x 13½"	13½" x 17½"	14½" x 14½"	14½" x 19½"	17½" x 17½"	19½" x 19½"
Price	PDC99CM \$163.26	PDC913CM \$171.87	PDC1212CM \$179.21	PDC1216CM \$202.08	PDC1313CM \$180.51	PDC1318CM \$208.21	PDC1616CM \$208.21	PDC1818CM \$218.32

Premier Damper Cap



National Chimney's Premier Damper Cap is made of 304 stainless steel with a Lifetime Guarantee. All Premier Damper Caps have a removable lid for easy access for cleaning. The lid is 15% larger, giving more protection from the elements limiting ice and snow build-up even in the harshest weather. It has an insulated lid with ½" thick insulation sandwiched between 2 pieces of 24ga 304 sheet steel to provide extra protection from condensation. Premier Damper Caps are made standard with ¾" expanded mesh screen and are also offered in 5/8" California Mesh. Comes with a 50' cable, handle, and silicone.



C Size	9" x 9"	9" x 13"	12" x 12"	12" x 16"	13" x 13"	13" x 18"	16" x 16"	18" x 18"
Tile Sizes O.D.	8" x 8" 9" x 9" 10" x 10"	8" x 12" 9" x 13" 10" x 14"	11" x 11" 12" x 12"	11" x 15" 12" x 16" 13" x 17"	13" x 13" 14" x 14"	12" x 17" 13" x 18" 14" x 19"	15" x 15" 16" x 16" 17" x 17"	17" x 17" 18" x 18" 19" x 19"
Base opening	10½" x 10½"	10½" x 14½"	13½" x 13½"	13½" x 17½"	14½" x 14½"	14½" x 19½"	17½" x 17½"	19½" x 19½"
Price	PDC99 \$190.45	PDC913 \$199.65	PDC1212 \$207.51	PDC1216 \$238.55	PDC1313 \$208.89	PDC1318 \$238.55	PDC1616 \$249.35	PDC1818 \$249.35

Dampers

HY-C Damper Kits

304 Stainless Steel damper kits are available in both 13" x 13" and in 13" x 20½".

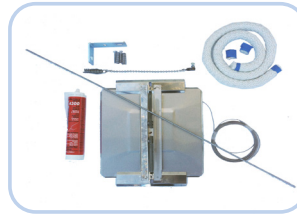

13" X 13" DAMPER KIT
HYCUD1313: \$164.39

13" X 20.5" DAMPER KIT
HYCUD1320: \$170.99

Drop-In Damper



- 304 Stainless Steel
- Lifetime Warranty
- 50' cable included
- Use on round, square or rectangle flue tiles, flexible or rigid stainless liner, factory built chimney, or solid pack chimney liner
- Recessed 6"
- Ideal for installations where a standard top mounting damper is not suitable
- Can be used with our Rain Caps, Top Kits or Premier Tops

Do not use on chimneys venting gas logs.



PDD6	PDD7	PDD8	PDD813	PDD9	PDD10	PDD11	PDD12	PDD1212	PDD1313	PDD14	PDD16
\$126.02	\$129.98	\$143.35	\$118.16	\$147.30	\$152.80	\$174.08	\$178.02	\$126.02	\$135.48	\$212.67	\$230.01

Bernard Dalsin MFG Chim-A-Lator Deluxe Fireplace Damper

The six-position lever handle not only makes this damper one of the easiest to use top mounted dampers on the market today, but allows you to control the amount of draft. (Includes a 30' cable and 7' cable shield.)

C Size	Fits Inside Flue Sizes	Deluxe Damper Cap
8" x 8"	7" x 9 1/4" to 7" x 9 1/4"	CD88 \$286.82
8" x 13"	7" x 9 1/4" to 11" x 13 1/2"	CD813 \$286.82
8" x 18"	7" x 9 1/4" to 16" x 18 1/4"	CD818 \$409.42
12" x 12"	10" x 12 1/4" to 10" x 12 1/4"	CD1212 \$301.44
13" x 13"	11" x 13 1/2" to 10" x 12 1/4"	CD1313 \$301.44
13" x 18"	11" x 13 1/2" to 16" x 18 1/4"	CD1318 \$409.42
18" x 18"	16" x 18 1/4" to 16" x 18 1/4"	CD1818 \$514.02

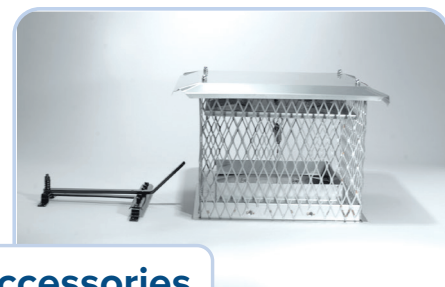

Accessories

50' REPLACEMENT CABLE
CD50RC: \$35.99

CABLE SHIELD/PROTECTOR (15 FT)
CD15CC: \$33.75

CABLE ASSEMBLY INSTALL PACK
CD30CA: \$52.87

10" DELUXE EZ GRIP HANDLE
CDDH: \$25.87

Top Damper

The Top Damper seals out rain, snow and sleet while sealing in “paid” heat and air-conditioning. In its closed position it is virtually invisible from the ground. The stainless steel and aluminum design ensures that it won’t rust or stain your chimney. But the most exciting benefit of The Top Damper is that it doesn’t require a chimney fire safety device. In addition, we have taken some weight out of the lid allowing this damper to open higher than the competitions’.

Installation is easy! Just use the adhesive to attach the damper at the top, then simply drill two holes and use the nail anchors to mount the bracket in the firebox. The mounting hardware consists of adhesive, 30’ stainless steel cable, fireplace bracket, anchors, spring handle, lid-release pull and even an allen wrench. You may use the Energy Top Adapter Ring, if desired. Just drill attachment holes in the damper frame for mounting. The RS Adapter may be used to adapt The Top Damper to a round liner or solid-pack Class-A pipe. Extra hardware packs are also available. The Top Damper carries a Limited Lifetime Warranty.



C 8” x 8”	TD88 \$179.57
C 8” x 17”	TD817 \$228.42
C 9” x 13”	TD913 \$182.57

C 13” x 13”	TD1313 \$188.59
C 13” x 18”	TD1318 \$246.45
C 18” x 18”	TD1818 \$293.05

Note: No safety device (fusible link) is needed, as the lid is aluminum and will melt in the event of a chimney fire.

Top Damper +

The Top Damper + comes with a premium quality stainless steel cap to provide spark protection and defend against animal/debris. Its special design seals out rain, snow, and sleet while sealing inside heat during the winter and A/C during the summer. Installation is quick. The damper frame secures to the top of the chimney with a high-temperature adhesive. Included are installation instructions, high-temperature adhesive, a 30’ cable, firebox mounting bracket, handle, and hardware. The Top Damper + carries a Lifetime Warranty.



C 8” x 8”	TDP88 \$308.12
C 8” x 17”	TDP817 \$376.51
C 9” x 13”	TDP913 \$312.94
C 13” x 13”	TDP1313 \$334.67
C 13” x 18”	TDP1318 \$398.23
C 18” x 18”	TDP1818 \$498.00

Install Kit



INSTALL KIT W/ 30’ CABLE
TDIP: \$37.25

INSTALL KIT (NO CABLE)
TDHK: \$19.37

Contains: Chain/handle assembly, bracket with nail anchors, allen wrench, and silicone.

Dampers

Energy Top Damper

The Energy Top Damper is a low-profile top mounted damper that also serves as a chimney cap. In the closed position, it is virtually invisible from the ground. It provides a tight, gasketed fit that seals heat. The Energy Top Damper seals out weather, insects, birds and animals. A slight pull on the chain releases the spring-loaded top into the open position. When open, this damper design is least obstructive to exiting smoke. Damper includes a Lifetime Warranty, 30' cut-to-fit cable, fireplace bracket, cool touch spring handle, mounting adhesive and hardware. **Do not use on chimneys venting gas logs.**



C Size	8" x 8"	8" x 17"	9" x 13"	13" x 13"	13" x 18"	18" x 18"
Fits Flue	7" x 7" to 10" x 10"	7" x 15" to 10" x 18"	7" x 10" to 10" x 13"	10" x 10" to 13" x 13"	10" x 15" to 13" x 18"	15" x 15" to 18" x 18"
Energy Top	ET88 \$202.61	ET817 \$253.78	ET913 \$221.71	ET1313 \$229.91	ET1318 \$277.66	ET1818 \$311.78

Energy Top + Damper

The Energy Top + Damper is about 90 percent more efficient than traditional dampers. Install at the top of the chimney and completely seal the flue shut with a flexible silicone rubber gasket when the fireplace is not in use. Energy Top + Dampers prevent heat from escaping up the chimney and chilly drafts from entering the home. The Energy Top + not only is a top sealing damper, but it also serves as a chimney cap/spark arrestor.



C Size	8" x 8"	8" x 17"	9" x 13"	13" x 13"	13" x 18"	18" x 18"
Energy Top +	ETP88 \$319.69	ETP817 \$425.84	ETP913 \$354.19	ETP1313 \$377.42	ETP1318 \$421.85	ETP1818 \$549.88

Energy Top Install Kit



50' CABLE
ET50RC: \$26.82

ET INSTALL KIT (NO CABLE)
ETHK: \$19.37

Install Kits Contain: chain assembly, bracket, nail anchors, adhesive and allen wrench.

Sealtight Damper Accessories



50' SEALTIGHT CABLE
ST50RC: \$32.78



ST INSTALL KIT (NO CABLE)
STHK: \$19.37

Sealtight Damper

This is a great option for homeowners who don't want a cap visible on their chimney. The Sealtight Damper attaches to the top of the flue. It provides a tight gasketed fit to seal out weather, insects, birds and other animals while keeping heat in. (This damper can also be installed beneath a HY-C chimney cap.) Each damper kit includes a Lifetime Warranty, 30' cut-to-fit cable, fireplace bracket, cool-touch spring handle, mounting adhesive and hardware. Do not use on chimneys venting gas logs.



C Size	8" x 8"	8" x 17"	9" x 13"	12" x 16"	13" x 13"	13" x 18"	18" x 18"
Fits Flue Sizes	6 3/4" x 6 3/4" to 9" x 9"	6 1/4" x 14 1/2" to 8 3/4" x 16 3/4"	6 1/2" x 10 1/2" to 9" x 12 3/4"	9 1/4" x 13" to 11 3/4" x 15 1/2"	10 1/8" x 10 1/8" to 12 3/4" x 12 3/4"	9 5/8" x 15" to 12 3/4" x 17 1/2"	15" x 15" to 17 3/4" x 17 3/4"
Sealtight Damper	ST88 \$175.36	ST817 \$195.47	ST913 \$176.16	ST1216 \$229.27	ST1313 \$184.21	ST1318 \$218.81	ST1818 \$285.59
Access Plate	Not Available	Not Available	Not Available	STAP1216 \$40.94	STAP1313 \$40.94	STAP1318 \$40.94	STAP1818 \$54.59

Lock-Top Damper (LT)

Lock-Top damper seals out pests and weather problems. It is a low-cost solution to replace throat dampers to help prevent heat and air conditioning loss from your customer's home. Damper includes 30' cable, adhesive, mounting hardware and Lifetime Warranty. Do not use Lock-Top dampers with gas logs.

C Size	Fits Inside Flue Sizes	Lock-Top
8" x 8"	6" x 6" to 9" x 9"	LT88 \$139.24
8" x 13"	6" x 9" to 9 1/2" x 12 1/2"	LT813 \$142.73
8" x 17"	6" x 14" to 9" x 17 1/2"	LT817 \$179.52
13" x 13"	9" x 9" to 12 1/2" x 12 1/2"	LT1313 \$149.90
13" x 17"	9" x 14" to 12 1/2" x 17 1/2"	LT1317 \$187.71
17" x 17"	14" x 14" to 17 1/2" x 17 1/2"	LT1717 \$220.12



50' CABLE
50LTRC: \$18.38

CABLE SHIELD (4' LT/LYO)
LTSLEEVE: \$15.55

C Size	6"	7"	8"	9"	10"	11"	12"
Size Lock-Top	LT88	LT88	LT88	LT1313	LT1313	LT1313	LT1313
RS Adapter	Not Available	LTRS7 \$87.73	LTRS8 \$89.27	LTRS9 \$93.24	LTRS10 \$101.01	LTRS11 \$102.17	LTRS12 \$104.67

Flue Caps, Dampers, & Accessories

STORMSHIELD

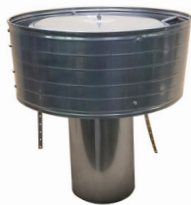

Tallboy

A new StormShield with a slip collar that extends 15" below the bottom lid assembly. Tie down straps are included (3) to secure the cap and eliminate liner float. 100% 304 Stainless insures a long life.

INSIDE FLUE	LID DIA	STORMSHIELD TALLBOY	
6"	16"	IC6SSTDWTB	\$258.16
7"	16"	IC7SSTDWTB	\$258.16
8"	16"	IC8SSTDWTB	\$263.76
8" Oversize	19"	IC8SSTDWOSTB	\$280.56
9"	16"	IC9SSTDWTB	\$263.76
9" Oversize	19"	IC9SSTDWOSTB	\$280.56
10"	16"	IC10SSTDWTB	\$263.76
10" Oversize	19"	IC10SSTDWOSTB	\$280.56
11"	19"	IC11SSTDWTB	\$303.24
12"	19"	IC12SSTDWTB	\$350.00

Masonry Adapters

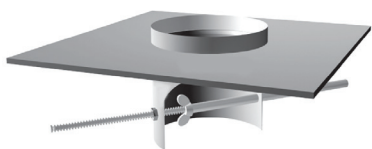

Adapt your Vacu-Stack or WeatherShield to any standard masonry flue using this adapter.

HOLE DIAMETER	PLATE DIMENSION		
5"	10" x 10"	ICAD5	\$36.96
6"	10" x 10"	ICAD6	\$36.96
7"	10" x 10"	ICAD7	\$36.96
8"	14" x 14"	ICAD8	\$41.72
9"	14" x 14"	ICAD9	\$41.72
10"	14" x 14"	ICAD10	\$41.72
12"	14" x 14"	ICAD12	\$49.28

WEATHERSHIELD

Chimney Cap Model WSA



A unique alternative to the traditional chimney cap. Its 304 stainless steel construction assures superior corrosion resistance to weather and the hostile flue gas environment.

Despite adverse weather, the WeatherShield will not rust. For use with solid pack Class A, masonry, and single wall chimneys keep out rain, snow, leaves, and animals, but keep sparks in. **Larger sizes available, call for quote.**

C	INSIDE FLUE DIAMETER	MODEL WSA	
		STAINLESS STEEL	COPPER
3"	3"	IC3WS	IC3WSC
		\$74.20	\$132.72
4"	4"	IC4WS	IC4WSC
		\$74.20	\$132.72
5"	5"	IC5WS	IC5WSC
		\$74.20	\$132.72
6"	6"	IC6WS	IC6WSC
		\$74.20	\$132.72
7"	7"	IC7WS	IC7WSC
		\$74.20	\$132.72
8"	8"	IC8WS	IC8WSC
		\$74.20	\$132.72
9"	9"	IC9WS	IC9WSC
		\$99.12	\$195.16
10"	10"	IC10WS	IC10WSC
		\$99.12	\$195.16
11"	11"	IC11WS	IC11WSC
		\$130.48	\$269.08
12"	12"	IC12WS	IC12WSC
		\$177.80	\$269.08

WEATHERSHIELD

Chimney Cap Model TDW

This model is made to fit air-insulated Class A double or triple wall chimneys. 316 Marine also available, **call for quote.**



C	INSIDE FLUE DIAMETER	AIR-COOLED TDW	
		STAINLESS STEEL	COPPER
5"	ICWSA5TDW \$145.88	ICWSC05TDW \$218.25	
6"	ICWSA6TDW \$145.88	ICWSC06TDW \$218.25	
7"	ICWSA7TDW \$145.88	ICWSC07TDW \$218.25	
8"	ICWSA8TDW \$145.88	ICWSC08TDW \$218.25	
9"	ICWSA9TDW \$145.88	ICWSC09TDW \$314.50	
10"	ICWSA10TDW \$172.20	ICWSC10TDW \$314.50	
11"	ICWSA11TDW \$198.80	ICWSC11TDW \$383.64	
12"	ICWSA12TDW \$223.16	ICWSC12TDW \$383.64	
13"	ICWSA13TDW \$242.20		

Conversion Kits

Convert your Weathershield into a Stormshield to keep out driving rains; also functions similar to a Vacu-Stack when there's wind related downdrafts.

FOR 5", 6", 7" & 8" WEATHERSHIELDS
ICSS13: \$59.78

FOR 9", 10" WEATHERSHIELDS | 6"-10" TDW'S
ICSS16: \$80.20

FOR 11", 12" WEATHERSHIELDS, TDW'S & OS
ICSS19: \$100.70

Lock-Top II Damper (LTII)

Lock-Top damper has a specially designed chimney cap. It comes fully assembled and ready to install directly to the flue tile.



(Includes a Lifetime Warranty, 30' stainless steel cable, adhesive, and mounting hardware) Do not use Lock-Top dampers with gas logs.

C	Size	Fits Inside Flue Sizes	Lock-Top
	8" x 8"	6" x 6" to 9" x 9"	LTII88 \$206.11
	8" x 13"	6" x 9" to 9 1/2" x 12 1/2"	LTII813 \$227.37
	8" x 17"	6" x 14" to 9" x 17 1/2"	LTII817 \$276.40
	13" x 13"	9" x 9" to 12 1/2" x 12 1/2"	LTII1313 \$249.15
	13" x 17"	9" x 14" to 12 1/2" x 17 1/2"	LTII1317 \$244.73
	17" x 17"	14" x 14" to 17 1/2" x 17 1/2"	LTII1717 \$297.70



Flue Caps & Accessories

VACU-STACK Caps

The premier chimney cap for solving common wind-related chimney draft problems, Vacu-Stack caps protect the chimney from rain, snow, debris, and animals. The Vacu-Stack is made to fit solid pack Class A, Masonry, or Single Wall Chimneys.

Stop down drafts and smoking caused from:

- Mountain winds in homes near slopes
- Wind deflected by tall trees
- Erratic, turbulent wind around buildings or other obstructions
- Appliances vented through the side of buildings

It is made of 304 stainless steel and available in 3" - 16" round diameters and in 8" x 12" and 12" x 16" rectangular sizes. To install, simply slide the Vacu-Stack into the pipe and seal with a high temperature silicone sealant. **Available in 316**

Marine and Copper, call for quote.

C	INSIDE FLUE DIAMETER	MODEL VSS
	3"	IC3VS \$82.04
	4"	IC4VS \$88.20
	5"	IC5VS \$93.52
	6"	IC6VS \$101.36
	7"	IC7VS \$102.76
	8"	IC8VS \$124.04
	9"	IC9VS \$174.44
	10"	IC10VS \$180.88
	12"	IC12VS \$346.92
	8" x 12"	IC812VS \$161.84
	12" x 16"	IC1216VS \$360.36

VACU-STACK Model TDW

With its purpose the same as the original Vacu-Stack, this model is specifically designed for use with double or triple wall air-cooled or air-insulated chimneys. The new one-piece Vacu-Stack TDW design for air cooled chimneys is now leakproof because it is self-flashing. This new design eliminates the need to caulk and seal the VSS unit to the termination cover. **Larger sizes available, call for quote.**



C	INSIDE FLUE DIAMETER	AIR-COOLED TDW
	6"	ICVS6TDW \$171.64
	7"	ICVS7TDW \$174.44
	8"	ICVS8TDW \$192.36
	9"	ICVS9TDW \$241.92
	10"	ICVS10TDW \$257.60

Vacu-Stack Screens

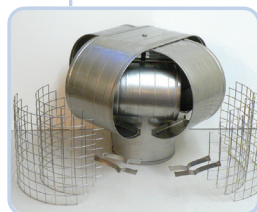

Other sizes available. Call for quote.

**FITS 6" & 7" VACU-STACK
VSSA671: \$21.84**

**FITS 8" VACU-STACK
VSSA881: \$24.64**

**FITS 9" & 10" VACU-STACK
VSSA911: \$29.40**

Air Cooled VACU-STACK Preassembled With Screens

C	INSIDE FLUE DIAMETER	AIR-COOLED TDW
	7"	ICVS7TDWWS \$207.48
	8"	ICVS8TDWWS \$228.20
	9"	ICVS9TDWWS \$282.52
	10"	ICVS10TDWWS \$298.20
	11"	ICVS11TDWWS \$428.12
	12"	ICVS12TDWWS \$422.25

Vacu-Stack Black, Vacu-Stack Antique Brass, Weathershield Black, Weathershield Antique Brass. Stainless steel doesn't have to be shiny and silver. Now available in customer-pleasing black and antique brass, these caps are made of the same quality austenitic stainless steel but are powder coated to give your customers some exciting new color choices. **Call for quote.**



VACU-STACK Tallboy

A new Vacu-Stack with a slip collar that extends 15" below the bottom lid assembly. Tie down straps are included (3) to secure the cap and eliminate liner float. 100% 304 Stainless insures a long life; 1/2" (S5) and 1"(S1) screens available.

INSIDE FLUE	LID DIA	VACU-STACK TALLBOY
6"	16"	IC6VSSTDWTB \$205.24
7"	16"	IC77VSSTDWTB \$208.04
8"	16"	IC8VSSTDWTB \$231.56
8" Oversize	19"	IC8VSSTDWOSTB \$242.76
9"	16"	IC9VSSTDWTB \$286.72
9" Oversize	19"	IC9VSSTDWOSTB \$298.76
10"	16"	IC10VSSTDWTB \$302.40
10" Oversize	19"	IC10VSSTDWOSTB \$313.60
11"	19"	IC11VSSTDWTB \$426.72
12"	19"	IC12VSSTDWTB \$471.52



WEATHERSHIELD Tallboy

A new WeatherShield with a slip collar that extends 15" below the bottom lid assembly. Tie down straps are included (3) to secure the cap and eliminate liner float. 100% 304 Stainless insures a long life.

INSIDE FLUE	LID DIA	WEATHERSHIELD TALLBOY
6"	16"	IC6WSATDWTB \$187.60
7"	16"	IC7WSATDWTB \$187.60
8"	16"	IC8WSATDWTB \$187.60
8" Oversize	19"	IC8WSATDWOSTB \$198.80
9"	16"	IC9WSATDWTB \$187.60
9" Oversize	19"	IC9WSATDWOSTB \$203.84
10"	16"	IC10WSATDWTB \$192.64
10" Oversize	19"	IC10WSATDWOSTB \$203.84
11"	19"	IC11WSATDWTB \$236.60
12"	19"	IC12WSATDWTB \$261.24

Dampers, Fans, & Adapters

Fireplace Dampers

For sizing, visit chimneyfans.com/sizing.aspx

- Prevents backdraft/excess heat from escaping fireplace
- Easy installation, maintenance-free
- Mechanical Fireplace Dampers



Controls & Accessories



ADC150 CONTROL



EFC211 SWITCH



XTP2 PRESSURE TRANSDUCER

Manual

Manual damper for solid fuel applications

	Manual Dampers	Item #	Price
C	8" MFD-S for RS9 and RS12	ENE3808	\$671.62
C	10" MFD-S for RS9 or RS12	ENE3810	\$730.94
C	12" MFD-S for RS-9 or RS12	ENE3812	\$787.97
C	8" MFD-S for RS14 or RS16	ENE3908	\$753.98
C	10" MFD-S for RS14 or RS16	ENE3910	\$814.46
C	12" MFD-S for RS14 or RS16	ENE3912	\$874.94
C	14" MFD-S for RS14 or RS16	ENE3914	\$934.27

Mechanical

Automated damper for non-solid fuel applications

	24Volt	120Volt	Size	For Model Numbers:	Price
C	EXH280624	EXH2806120	6"	RS9 & RS12	\$1,683.61
C	EXH280824	EXH2808120	8"	RS9 & RS12	\$1,752.42
C	EXH281024	EXH2810120	10"	RS9 & RS12	\$1,837.83
C	EXH281224	EXH2812120	12"	RS9 & RS12	\$1,961.75
C	EXH290824	EXH2908120	8"	RS14 & RS16	\$1,822.71
C	EXH291024	EXH2910120	10"	RS14 & RS16	\$1,961.82
C	EXH291224	EXH2912120	12"	RS14 & RS16	\$2,097.15
C	EXH291424	EXH2914120	14"	RS14 & RS16	\$2,166.69
C	EXH291624	EXH2916120	16"	RS14 & RS16	\$2,388.21
C	EXH291824	EXH2918120	18"	RS14 & RS16	\$2,527.32
C	EXH292024	EXH2920120	20"	RS14 & RS16	\$2,664.15

	Description	Item #	Price
C	ADC100 Fan & Damper Control w. PDS1 - Monitors set draft pressure and maintains proper fan speed*	ADC100	\$590.98
C	ADC150 Modulating Fan & Damper Control w. XTP2 Monitors draft pressure and modulates fan speed on up to 2 appliance to maintain draft*	EXH0062	\$1,630.69
C	EFC 211 Control Switch - Controls fan speed and alarms if there is an issue**	EXH0090	\$895.86
C	FSC5 Fan Speed Control - Allows user to control fan speed using only necessary energy to maintain desired air flow	EXH11265	\$63.51
C	FSC8 Fan Speed Control - Allows user to control fan speed using only necessary energy to maintain desired air flow	EXH11268	\$154.23
C	XTP2 Pressure Transducer [†] - Monitors draft pressure and communicates to fan control	EXH0085	\$660.75
C	PDS1 Proven Draft Switch [†] - Shuts down appliance if insufficient draft is present*	EXH1130	\$219.99
C	RSD Dilution Bolts - Allows vibration-free operation and dilution air to cool off flue gases	EXH1125	\$53.67

Energex Chimney Fans

- Creates proper draft to eliminate fireplace smoking
- Energy efficient and quiet operation
- Easy installation, maintenance-free
- ISO 9001 certified
- RS Fan for non-solid fuel (gas/oil) - up to 482°F
- RSHT Fan for solid fuel (wood/pellet/coal/etc.) - up to 1000°F

For sizing, visit chimneyfans.com/sizing.aspx

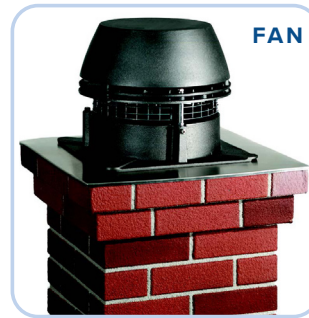

Item #	RS Chimney Fan	Price
RS9	9" Fan, 12"x12" base, 10" Ht	\$2,041.20
RS12	12" Fan, 14"x14" base, 11" Ht	\$2,408.61
RS14	14" Fan, 16"x16" base, 13" Ht	\$2,589.60
RS16	16" Fan, 19"x19" base, 16" Ht	\$3,761.26

Item #	RS Chimney Fan	Price
RSHT009*	9" High Temp Fan 12"x12" base, 12"H	\$2,392.29
RSHT012*	12" High Temp Fan 14"x14" base, 13" H	\$2,824.34
RSHT014*	14" High Temp Fan 16"x16" base, 15" H	\$3,036.62
RSHT016*	16" High Temp Fan, 19"x19" base 16"H	\$4,409.67

Air-Cooled Chimney Adapters

Fits Models	Size	Item #	Price
RS9 & RS12	6"	FR2006A	\$392.21
RS9 & RS12	8"	FR2008A	\$392.21
RS9 & RS12	10"	FR2010A	\$412.63
RS12 & RS14	8"	FR3008A	\$412.63
RS12 & RS14	10"	FR3010A	\$412.63
RS12 & RS14	11"	FR3011A	\$412.63

Fits Models	Size	Item #	Price
RS12 & RS14	12"	FR3012A	\$412.63
RS12 & RS14	13"	FR3013A	\$412.63
RS16	10"	FR4010A	\$412.63
RS16	11"	FR4011A	\$412.63
RS16	12"	FR4012A	\$412.63
RS14 & RS16	13"	FR4013A	\$412.63

Steel Chimney Adapters

- Designed to slide into chimney for a tight fit
- Stock sizes available for most common sizes
- Custom sizes available upon request

For RS9, Use:		
Size	Item #	Price
5"	FR2005	\$316.87
6"	FR2006	\$316.87
7"	FR2007	\$316.87
8"	FR2008	\$316.87
10"	FR2010	\$301.39
12"	FR2012	\$383.77

For RS12 & RS14, Use:		
Size	Item #	Price
6"	FR3006	\$316.87
7"	FR3007	\$316.87
8"	FR3008	\$316.87
10"	FR3010	\$301.39
12"	FR3012	\$383.77
14"	FR3014	\$383.77
16"	FR3016	\$383.77

For RS16, Use:		
Size	Item #	Price
8"	FR4008	\$392.93
10"	FR4010	\$383.77
12"	FR4012	\$383.77
14"	FR4014	\$383.77
16"	FR4016	\$383.77
18"	FR4018	\$383.77
20"	FR4020	\$673.87
22"	FR4022	\$673.87
24"	FR4024	\$673.87

HEARTH ACCESSORIES





Premier Refractory Panels

Cut to fit Refractory Panels are manufactured using the highest quality materials available in the industry. Reinforced with a stainless steel structural lath for strength and durability. Supplying our customer with top quality products is imperative to National Chimney. Refractory Panels require freight truck transport.

Always use the following safety materials when cutting refractory panels because refractory dust can cause eye and lung irritation:

- Safety glasses
- Gloves
- Dust Mask

See index for safety glasses, gloves, and dust masks.



24"HT X 34" W, 1 1/8" THICK
(2"X6.5" SMALL BRICK PATTERN)
GRAY PFP2433SB: \$94.43



24"HT X 42" W, 1 1/8" THICK
(4"X8" LARGE BRICK PATTERN)
GRAY PFP2442LB: \$111.27



12" X 24", 2" THICK
(NO BRICK PATTERN)
PFP1224: \$71.21

15.75" X 24", 2" THICK
(NO BRICK PATTERN)
PFP1524: \$83.07

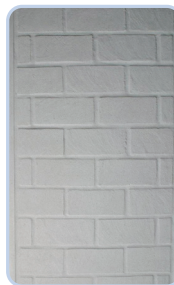

42"HT X 24"W, 1 1/8" THICK
(4"X8" LARGE BRICK PATTERN)
GRAY PFP4224LB: \$145.73

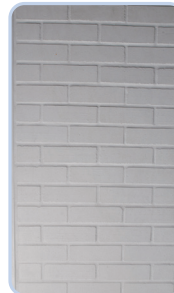

42"HT X 24"W, 1 1/8" THICK
(2"X6.5" SMALL BRICK PATTERN)
GRAY PFP4224SB: \$145.73

**This Product does not qualify for free shipping.*

Skamol Panels

Skamol panels are an attractive, factory-built panel replacement option. Not only are they easy to work with but they feature a three dimensional appearance. Easy to cut and easy to install. Makes for a quicker, cleaner installation. Dimensions: 1" x 24" x 39 5/8".

- Lightweight vermiculite
- Cuts with a standard handsaw
- Superior insulation value
- High mechanical strength
- Thermal shock resistance
- No ceramic fibers or dust

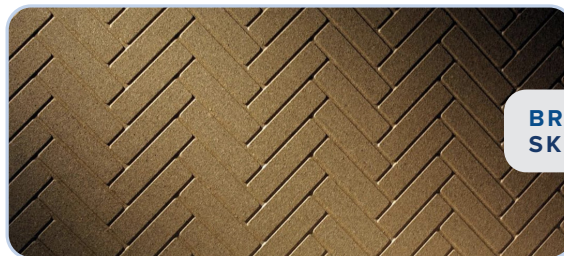

BRICK PATTERN
SKB: \$97.37

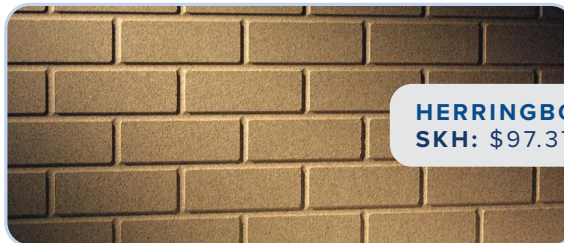

HERRINGBONE PATTERN
SKH: \$97.37

Firebacks & Smokeguards

REMOVAL AND CUT-TO-FIT INSTRUCTIONS

Safety gear is recommended when removing or installing refractory panels. See Index for Safety Items.

*This Product does not qualify for free shipping.

Curing Information

The panels require curing by exposing them to very low heat for a short period of time, 5 to 6 times. This ensures all the moisture is eliminated from the panel to prevent future cracking.

FIRST AID PROCEDURES

INHALATION: Go into an area that is dust free; seek medical attention if problems persist.

EYE CONTACT: Go into an area that is dust free and flush eyes with water for a minimum of 15 minutes.

SKIN CONTACT: Wash skin thoroughly.

DIAMOND BLADES

Use these wet or dry to cut the refractory panels.

4.5" x .080" General Purpose	LDSL04580P	\$33.00
4" x .250" Tuck Pointing	LDTPSG04250P	\$47.50
4.5" x .250" Tuck Pointing	LDTPSG45250P	\$81.90
7" x .090" General Purpose	LDTSLG07080P	\$55.00

BACK REMOVAL AND INSTALLATION

1. Removing back refractory panels require working slowly and being careful not to break fragile old refractory panels. Make sure to remove the side that does not have the gas line. Unscrew the retaining clips, located at the top and front of the panel.
2. Lift the panel out of the firebox.
3. Measure the length and height of the refractory panel. Mark your cut to fit panel and cut using a circular saw masonry blade.
4. Using retaining clips, install the new refractory panel.
5. Reinstall old side refractory panels with retaining clips
6. See note above for important information regarding curing.

SIDE REMOVAL AND INSTALLATION

1. Unscrew the retaining clips of the panel you want to take off on the top and front of the panel.
2. Mark the cut to fit panel with the desired length and height dimensions. Cut panel using a circular saw masonry blade.
3. Using retaining clips, install the new refractory panel.
4. See note above for important information regarding curing.

BOTTOM REMOVAL AND INSTALLATION

1. Starting with the side panels and end with the bottom panel, remove all panels from firebox.
2. Use the factory edge towards the front of the firebox and measure bottom panel. Cut panel to determined measurements.
3. Install panel with the factory edge towards the front of the firebox.
4. Install the back and side panels.
5. See note above for important information regarding curing.

HY-C Firebacks

Firebacks protect the structural integrity of the fire box. They shield masonry from 1/3 of the heat that may cause damage. Firebacks increase energy output by reflecting heat & light back into the room. HY-C Firebacks have a lighter stainless steel construction which makes them less expensive and easier to place than cast iron firebacks. All HY-C firebacks have a slotted base which allows for adjustable installation (65° to 90°).

**Be advised: paint will burn off with use.*

15" x 15" Stainless Fireback Painted Black	FB1515	\$63.17
16" x 18" Stainless Fireback Painted Black	FB1618	\$80.99
20" x 20" Stainless Fireback Painted Black	FB2020	\$109.25
24" x 24" Stainless Fireback Painted Black	FB2424	\$138.77
27" x 27" Stainless Fireback Painted Black	FB2727	\$160.85

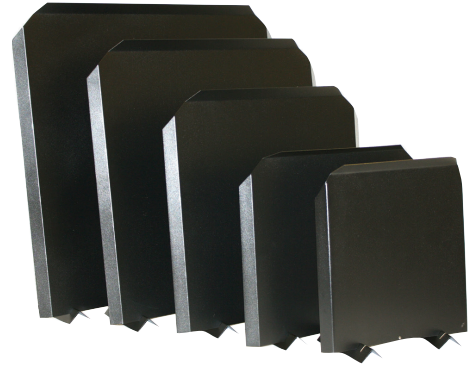

Smokeguards

Most fireplaces smoke because the opening is too high. Smokeguard lowers the fireplace opening, holds in smoke, and easily corrects the problem. Available in brass and black to fit fireplaces 28 1/2" to 48" wide.



BEFORE

AFTER

Black		
4"	FSGBLK	\$62.27
6"	FSGBLK6	\$65.39
8"	FSGBLK8	\$69.17
Brass		
4"	FSGBR5	\$70.85

Pennsylvania Firebacks

CAST IRON

North Star	21 1/2" W x 19" HT	PFSF07	\$460.89
Mountain View	21 1/2" W x 21 1/2" HT	PFSF13	\$502.57
Small Oak	18" W x 16" HT	PZF01	\$384.60
Plain Great Oak	18" W x 20" HT	PFSF08	\$440.44
Winter	21 1/2" W x 21 1/2" HT	FSF09W	\$510.44

SAF-T-BOOTS

3"	1 1/2" to 3" steps	PFSB3	\$94.38
-----------	---------------------------	--------------	----------------

There are many other Pennsylvania Cast Iron Firebacks available upon request. Go to www.fireback.com to view.



Hearth Products

American Panel **Hearth Products**

American Panel Hearth Products Type II hearth pads. Built and tested to the new UL1618 Standard that was effective 2011. These hearth pads offer both ember protection and thermal protection. Built with a solid ¼" thick (at bottom) aluminum frame for strength, non-combustible substrates for safety, mechanically fastened into frame for strength, no carpet removal required – easier and quicker installation. Manufactured and assembled in the USA.

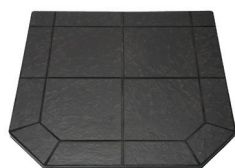

VOLCANIC SAND



DELHI SKY



TATARA

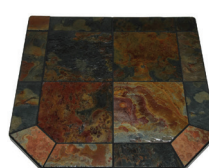

ASIAN SLATE

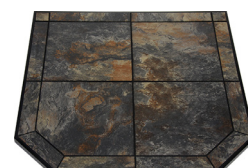

IMPERIAL BLACK

All either fit flush to a flat back wall or into a corner and have front corners cut (see photos above), but other options, colors and sizes are available, please call for quote.

Panels require freight truck transport.

Volcanic Sand 40" Corner		AP40SLVS	\$325.35
Volcanic Sand 48" Flat Back Wall		AP48DLVS	\$460.35
Delhi Sky 40" Flat Back Wall	Limited Availability	AP40DLDSKY	\$219.70
Imperial Black 40" Corner		AP40SLIB	\$325.35
Imperial 48" Flat Back Wall		AP48DLIB	\$425.25
Asian Slate 40" Flat Back Wall		AP40DLAS	\$351.00
Asian Slate 48" Flat Back Wall		AP48DLAS	\$460.35



18 x 48 Type 2 Hearth Extender	HYT2UL1848BL	\$60.59
28 x 32 Type 2	HYT2UL2832BL	\$78.59
32 x 42 Type 2	HYT2UL3242BL	\$113.99
36 x 36 Type 2	HYT2UL3636BL	\$95.99
36 x 48 Type 2	HYT2UL3648BL	\$131.99
36 x 52 Type 2	HYT2UL3652BL	\$149.39
40 x 48 Type 2	HYT2UL4048BL	\$167.39
48 x 48 Type 2	HYT2UL4848BL	\$176.99

HY-C **Stoveboards**

HY-C Company UL-Listed Stove Boards and Hearth Extenders protect your customer's floors from the intense heat, hot coals, ashes, and soot that wood stoves and fireplaces produce. They can also be used under other heating appliances such as kerosene, gas, and electric heaters. UL-Listed stove boards may be used as a wall shield to reduce a wood stove's clearance necessary to combustibles while protecting the walls from heat. Items and prices shown here are for black. Tile gray, woodgrain patterns, and additional sizes are non-stock, but available upon request.

Minuteman Cast Iron Door



COD88 & COD1212



COD812

Made of heavy duty cast iron, this door displays a glowing fire on its exterior. There are three sizes available:

8"X8" (OD= 10¹/₂"X10¹/₂"
COD88: \$51.57

8"X12" (OD= 11"X17¹/₂"
COD812: \$107.97

12"X12" (OD= 15¹/₂"X15¹/₂"
COD1212: \$138.51

Ashpit Door

Drop this cast iron door in the bottom of your customer's fireplace so they can sweep away their ashes. Fits 4.5"x9" opening, outside dimension is approx. 5³/₈"x9¹/₂".



ASHPIT DOOR
AP49: \$25.64

HY-C Fireplace Grates



One piece cast flat bottom style grate with 12" depth, 5" height for use in small fireplaces and Franklin Stoves.

17" W
HYCG17: \$91.19

22" W
HYCG22: \$103.79

HY-C Safe-T-Grate



Heavy duty self-feeding expandable fireplace grate. Safe-T-Grates are shipped knocked-down.

22" W
HYCGT22: \$130.55

1200° Stove Paint



Resists peeling and blistering when subjected to temperatures up to 1200°F. Renews and protects finishes on steel or cast iron stoves, ovens, grills and cookers. Dries to flat black finish.

1200 SPRAY 12 OZ -12/CS
80: \$13.43

A. W. Perkins

Stove & Grill Paint



Adheres to stainless and aluminum without primer. Won't peel or blister at 1400° F. Lower odor than competitive products. We stock in flat black but it is available in other colors, cases of 6. Call for a quote.

1400 SPRAY 12 OZ -12/CS
AWP90: \$12.21

Stove Thermometer



Helps monitor stove temperature to reduce chance of creosote buildup. Ceramic face will not fade and the strong magnet holds the thermometer in place on the stove top, door or flue pipe.

STOVE THERMOMETER
RU701: \$19.00

Cleaning Products

A. W. Perkins **HearthGlass Creme**



Mild abrasive and active ingredients combine to attack soot and creosote deposits on glass-ceramic windows of solid-fuel stoves and fireplace inserts. Silicone creates a slippery layer to make the next cleaning easier. **Not for tempered glass fireplaces.**

HEARTHGLASS CREME
AWP101A: \$4.86

A. W. Perkins **Gas Fireplace Glass-Ceramic Cleaner**



Dissolves white film build-up & soot on glass-ceramic windows of gas or wood fired heating appliances. Mild abrasive will not scratch glass-ceramics avoiding the micro-pitting of more aggressive products. This pitting leads to "hazy glass" & increases glass breakage.

8 OZ GFC CLEANER
AWP102A: \$5.20

A. W. Perkins **Big Stick Soot Remover**



A 3 oz. Toss-in tube containing soot and creosote removing compounds. Enhanced with the addition of our Magi-color Flame Crystals it burns with a blue-green flame.

TOSS IN 3 OZ STICK
AWP210: \$2.17

SaverSystems

ACS Home & Hearth Cleaner

Home and Hearth Cleaner is an industrial strength cleaner. It is a high alkalinity citrus detergent, containing biodegradable surfactants which effectively cut through smoke and creosote. It safely removes smoke and creosote stains from fireplace glass, hearths, stoves, brick, stone, and more. Home and Hearth Cleaner combines the natural cleaning power of citrus with strong cleaning agents to tackle most



tough household cleaning jobs. It is great for cleaning barbecue grills as well as clothing and equipment with smoke and soot. Home and Hearth Cleaner also works on walls, woodwork, kitchen surfaces and flooring and leaves no streaks or film. The product provides a quick easy way to clean while leaving a long-lasting scent of fresh oranges.

ACS HEARTH CLEANER
SSHHC: \$7.84

SaverSystems

Anti-Creo-Soot (ACS)

ACS is a non-toxic and environmentally safe liquid that attacks and destroys dangerous creosote and soot. Available in quarts or gallons. Encourage your customer to spray it daily into their fireplace or stove during low fire conditions. ACS will help prevent chimney fires and assist in cleaning the chimney more completely. It also controls excess ash and clogging in pellet stoves.



ACS 32 OZ. SPRAY BOTTLE
ACSQ: \$11.58

ACS 1 GAL
ACSG: \$32.27

ACS 16 OZ. SPRAY BOTTLE
(GAS LOG CARBON SOOT REMOVER)
ACSL: \$8.67

SaverSystems

Brick & Mortar Cleaner



Designed for use on brick and masonry surfaces. It effectively removes smoke, rust, and creosote stains, as well as mildew and algae. Available in a 2.5 gal container, covers 50-150 sq ft per gallon.

2.5 GAL
SSBMC: \$37.28

SaverSystems **Paint "N" Peel Fireplace Cleaner**

Paint on/Peel off. Cleaning smoke stains from your customer's fireplace front is just that easy. Now you can add cleaning smoke/soot stained fireplace fronts to your list of professional services. You paint it on and once dry, your customer peels it off. Their old, dingy fireplace front looks like new and there's no need for a return trip. The average job requires less than a gallon of Paint "N" Peel Fireplace Cleaner.



- Restores the appearance of nearly all masonry surfaces.
- Waterless—Simply paint on, let dry, & peel off.
- No noxious odors, no harsh chemicals.
- Tools clean easily with soap & water.

1 GAL
SSPPFC: \$85.56

HY-C **Soot Eraser**



Absorb soot, fly ash, and dirt on brick mantles, painted walls, woodwork and window blinds with this natural vulcanized rubber sponge.

SOOT ERASER
SSSE1: \$7.19

Rutland

Stage One Creosote Remover

Turns creosote into a brushable ash in pellet stoves, wood stoves, fireplace inserts and free-burning fireplaces. Makes chimney cleaning easier and reduces the danger of chimney fires. Safe to use with all types of chimneys.



2 LB CONTAINER
AW2012: \$9.55

*Limited Availability

Rutland **Fireplace Glass Cleaner**

Use this safe, non-acidic formula to remove creosote, soot and grime from fireplace doors and hearths.

Contains No Ammonia



GLASS CLEANER
82: \$8.21

Rutland **Kwik-Shot™ Soot Stopper Stick**

Just place one of these Kwik-Shot sticks on the fire to control soot and creosote build-up.



3 OZ STICK
RU100S: \$2.73

Rutland **Brick & Stone Cleaner**

Contains an industrial-strength solvent to dissolve buildup and a heavy-duty surface cleaner to penetrate and remove smoke residue, soot and creosote from masonry surfaces. No dangerous acids. For sealed surfaces only.



PINT
RUBSC: \$6.09

MASONRY REPAIR





INTRODUCING... **CHIMNEYTM DEFENDER**

Meredith Next Gen Built

National Backed



TO LEARN MORE, VISIT:

chimneydefender.com



Next Gen
Crown Repair

Waterproof Protection for Chimney Crowns

Next Gen Crown Repair creates a seamless waterproof shield that keeps water out for good, stopping leaks and restoring crowns that last a lifetime. Engineered for crown repair & resurfacing, new crown construction, exterior chimney corbels, and more.

1 gal: **\$81.98** 2 gal: **\$155.32**



Next Gen
Flashing Repair

Permanent Protection for Chimney Flashings

Next Gen Flashing Repair seals and protects vulnerable areas with a permanent, hybrid moisture-cure formula that bonds to metal, brick, stone, and roofing materials—creating a watertight barrier.

1 gal: **\$79.86**



Next Gen
Water Repellent

Long-term Waterproof Protection for Chimneys

Next Gen Water Repellent penetrates deep into masonry chimneys, walls, and concrete surfaces to stop water intrusion while allowing trapped moisture vapor to escape naturally. Provides long-lasting protection with a breathable, invisible barrier.

5 gal: **\$208.49**



Glazed
Creosote
Remover

A Safer Way to Remove Dangerous Creosote

Glazed Creosote Remover is engineered to chemically soften, absorb, and release glazed creosote—drying up to 50% faster than traditional systems, dramatically decreasing the risk of chimney fires and hidden flue damage.

25 lb: **\$195.68**



Sealants & Creosote Remover

SaverSystems ChimneySaver Water Repellent

The most common problem with masonry chimneys is water penetration. Saver Systems water repellent can prevent all types of water damage, such as staining, loss of insulation value, freeze-thaw damage, deterioration, and ultimately structure failure. Available in Water or Solvent base including V.O.C. Compliant Solvent-base. Product is covered by a 10-year warranty. Covers approx. 100 sq. ft. per gallon.



WATER BASE (5 GAL)
SSWR5: \$198.35

WATER BASE (30 GAL)
SSWR30: \$1,047.65

SOLVENT BASE (5 GAL)
SSPWR5: \$421.27

SOLVENT BASE (30 GAL)
SSPWR30: \$2,412.07

VOC SOLVENT BASE (1 GAL)
SSCSSBC: \$97.07

SaverSystems ChimneySaver Multi-Purpose Water Repellent



New Multi-Purpose Water Repellent can be used on a variety of substrates as well as on horizontal applications. Up to 1/4" penetration, creates a salt shield barrier on concrete, resistant to de-icing chemicals, 100% breathable, VOC compliant.

MULTIPURPOSE (5 GAL)
SSCSMP: \$240.94

SaverSystems Powdered Water Repellent

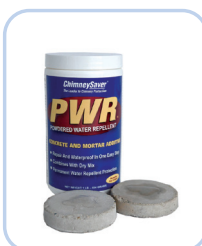

Just add 1 oz to every 15 lbs. of dry mortar mixture, then add water. Provides water repellent properties when the concrete and mortar cures.

POWDERED (1 LB)
SSPWR: \$38.34

SaverSystems All Weather CrownCoat Sealant (FORMERLY COLD WEATHER)

All Weather CrownCoat is a tough elastomeric coating that will cure in temperatures below freezing. This stops further water damage, even in the winter months. All Weather CrownCoat can be used in all weather and is available in 1 gallon pails – enough to do 3-4 average crowns. Light gray color.



CROWNCOAT (1 GAL)
SSCWCC1: \$84.91

SIPHON PUMP (FOR 30 GAL)
SSSIPHON: \$31.36



SaverSystems CrownSeal

This pre-mixed crown repair system forms a light gray, flexible, waterproof seal to protect the chimney crown. It is applied to the surface with a trowel or putty knife at a thickness of 1/8" - 1/4" (1/4" thickness yields 7-9 sq. ft. per gallon of coverage). Cures completely in 6-8 hours during warm weather or 24-72 hours in cooler weather. CrownSeal is available in 2 and 5 Gallon Containers.

CROWNSEAL (2 GAL)
SSCS2: \$139.06

CROWNSEAL (5 GAL)
SSCS5: \$304.78



SaverSystems CrownSaver

Use this durable waterproofer for the repair of Chimney Crowns. It covers approximately 30 square feet at 1/2" thickness (about 4 average crowns) when properly mixed. This product allows you to re-build and waterproof all at once. Option: can be used with form foil.

CROWNSAVER (5 GAL)
SSCR: \$95.89

FORM FOIL (9"X50')
SSFF: \$173.91



SaverSystems **FlashSeal**

FlashSeal is a long lasting flashing repair system designed to stop leaks from faulty or deteriorated flashings around chimneys, stacks, and vents. Available in Black, Brown, and White, it can be dyed to match your customer's roof. Simply apply FlashSeal with a brush around the area to be repaired, place a strip of reinforcement fabric over the base coat and apply another coat. (1) gallon covers 28 linear feet or 14 sq. ft. Reinforcement fabric is available in 6"x150' rolls.



BLACK (1 GAL)
SSFS: \$72.50

BROWN (1 GAL)
SSFSB: \$72.50

WHITE (1 GAL)
SSFSW: \$72.50

REINFORCEMENT FABRIC (6"X150")
SSFSRF: \$22.52

SaverSystems **Cre-Away**

By simply squeezing the 1 lb. bottle pointed directly up the flue near the top of the firebox, the powder is carried up the chimney coating the entire surface of the flue and enabling the ingredients to start working. It modifies third-degree creosote by converting it into a more brittle state. During the heating/cooling cycles the treated creosote loses its adhesive properties so it can be simply brushed away. Sprayer for use with 25 lb pail, sold separately.



SQUEEZE BOTTLE (1 LB)
SSCA: \$10.84

PRO STRENGTH (25 LB)
SSCA25: \$132.74

PRO APPLICATOR
SSCAPA: \$99.44

Crown Safe



Spread it and forget it! Crown Safe is a high-performing, brushable elastic sealant, with rubber-like flexibility designed to stop water intrusion into masonry chimney crowns, roofs, and various other building surfaces. Crown Safe's fibered formula produces a clear, see-through finish which is extremely flexible and highly resistant to tears, shears, stress, and weathering. The unique properties of this product allow successful application in extreme weather, such as freezing and wet conditions. Preferred by chimney and roofing professionals for its versatility, Crown Safe is the ultimate water intrusion prevention system! Available in conveniently sized one (1) gallon containers, and features better product coverage than the competition at up to 80 sq. feet per gallon! Avoid those costly return visits with this one step, single component, crown repair product and get the job done right, the first time!

CROWNSAFE (1 LB)
USCS: \$109.54

SaverSystems **CrownCoat**
Brushable Sealant



This crown repair product is the brush-on version of CrownSeal. Using a 3" or 4" bristle paint brush, brush a thin coat over the entire crown, wait a few minutes for a tacky film to form, then brush on a second heavier coat. CrownCoat cures completely within 2 - 4 hours and is available in a 2 or 5 gallon container. This will cover approximately 80-200 sq. ft. or 40 sq. ft. per gallon. Available in standard color (very light Gray) or Buff, a color more resembling concrete.



STD COLOR (2 GAL)
SSCC: \$147.52

BUFF (2 GAL)
SSCCB: \$147.58

STD COLOR (5 GAL)
SSCC5: \$296.07

BUFF (5 GAL)
SSCCB5: \$296.07

Poultice Creosote Remover (PCR) & Applicator

PCR should be used where glazed creosote is present in order to eliminate the dangers of chimney fires. PCR is designed to completely remove 3rd degree glazed creosote from flue tiles or stainless steel chimney liners. When applied, it dissolves and absorbs the creosote allowing it to fall off the sides of the flue tiles. Any remaining PCR can be easily removed by chimney sweeping or with a specially designed applicator tool.

Applicator Package Includes:

- (1) RS 44 Pulling head
- (1) Pulling head connector kit
- (1) 12"x12" foam cut w/bottom plate
- (1) 8"x12" foam cut w/bottom plate
- (1) 8"x8" foam cut w/bottom plate

**Requires use of a winch system.*



PCR
SSPCR: \$178.71

APPLICATOR PACKAGE
SSPCRA: \$486.74



Sealants & Repair

HeatShield Tie Coat Accelerator

Tie Coat Accelerator is added to each 50 lb. bucket of HeatShield Cerfractory Flue Sealant to reduce the drying time of the tie coat application, allowing you to perform the resurfacing repairs sooner and save time on the job.



PAIL (4 LB)
SSHSTCA: \$64.74

HeatShield Smoke Chamber Sprayer

This dual-gauge smoke chamber sprayer is a low pressure, high volume system with a 3/4" hose. It gives users more control for applying the correct amount of material for various smoke chambers. The spray gun, made by MarshallTown can be adjusted to 7 different spray settings and includes a clean-out valve on top for easy cleanup. The sprayer must be used with

a compressor with a minimum 5.0 CFM @ 60 PSI. Used for both SSPCR Poulitce Creosote Remover and SSCF Smoke Chamber Sealant.



SPRAYER
SSSPRAYSC: \$1,040.92

HeatShield PriorFire Formula 51

PriorFire Formula 51 is a smoke chamber restoration system designed to insulate fireplace smoke chambers for added safety, smooth jagged edges, corbels, and reshape the smoke chamber for increased fireplace safety and performance. This versatile product has a 20-year limited warranty and can be used to parge over masonry in smoke chambers to insulate from heat or cold, and it sticks to most anything. It's UL Listed zero clearance to combustibles when applied a minimum 1" thick to 4" nominal masonry. One of our customers described it as "the best parging product ever produced" try it and see if you don't agree.

PAIL (30 GAL)
SSFORM51: \$76.28



HeatShield Cerfractory Foam Smoke Chamber Sealant

Repairs masonry smoke chambers easily. No need to remove the damper or flue tiles. Greatly improves draft efficiency while adding an extra layer to insulate the chimney from surrounding building materials. Applied with a basic sprayer.

Exceeds ASTM & NFPA requirements. 20-Year limited warranty. Average smoke chamber requires 1-2 pails.



PAIL (3.5 GAL)
SSCF: \$142.76

HeatShield Chamber Coat

Chamber Coat is a trowel/pargeable smoke chamber repair product designed to smooth out corbels and fill gaps in smoke chamber walls. It insulates, strengthens, and improves efficiency of fireplace smoke chambers. It meets both NFPA and IRC requirements for parge coating of smoke chamber walls with a refractory mortar that passes ASTM C199 Medium Duty (5 hours at 2550°F).



PAIL (5 GAL)
SSCHC: \$53.50

HeatShield

Cerfractory Flue Sealant

The HeatShield Flue Sealant & Repair System was developed to restore flue tile and masonry chimney interiors to their original integrity. In suitable chimneys, HeatShield can provide a very effective and durable repair system. It can be applied solely to open mortar joints, or a thin coating can be applied to the entire flue to fill joints, seal cracks and structurally reinforce clay flue lined chimney interiors. Invented in Europe, HeatShield's hybrid "cerfractory" technology contains no cement or lime. It combines the strength of a high fired ceramic with the heat resistance of high temperature refractory cement. HeatShield Cerfractory Flue Sealant is supplied as a dry powder that is mixed with tap water on the job site immediately before

use. It air cures in about 48 hours and is ready for use. Restored flues are gas tight, moisture & acid resistant, with little to no effect on the functional cross sectional area of the flue.



PAIL (50 LB)
SSHSCFS: \$268.74

Chamber Safe

Chamber Safe is a high performance, refractory parging material designed to strengthen, streamline, and restore the critical smoke chamber area in masonry chimneys. Chamber Safe smooths jagged, corbelled walls typically found in the smoke chamber, and creates a smooth transition between the smoke chamber, and flue liner.



(5 GAL)
LCS: \$73.62

Rutland Fireplace Mortar 63, 63B, & 63G

Once fire cured, fireplace mortar is as strong as the firebrick itself. Use to patch fireplace fireboxes, bond firebrick to firebrick and re-point fireplace brick in the firebox.

Temperature rating: 2000°F. Requires heat to cure, may be painted once heat cured.



BLACK (10.3 OZ)
63: \$4.45

BUFF (10.3 OZ)
63B: \$4.45

GRAY (10.3 OZ)
63G: \$4.45

P.M.P. Premier Mortar Preserve

Flexible crown repair designed for use over exterior masonry, stuccos, poured concrete, pre-cast concrete, and concrete block. It forms a continuous seamless coating that preserves the crown. Can be applied in temperatures 40-90°F. Apply 1/16" thickness over the entire crown. Within 1 hour it should be tack free, weather resistant in 6 hours and cured completely in 72 hours. Gray in color. (5 Gallon Container yields 100 - 130 sq. ft.)



(2 GAL)
PMP2: \$143.40

(5 GAL)
PMP: \$248.13

HeatShield Adhesion Promoter

HeatShield Adhesion Promoter is a liquid additive. Add to HeatShield Cerfractory Flue Sealant or HeatShield Cerfractory Foam upon mixing to further promote adhesion/bonding to flue tiles and masonry surfaces. Because the interior surfaces of masonry chimneys and fireplaces are often difficult to clean and prep, the use of HeatShield Adhesion Promoter ensures maximum bonding potential.



(1 GAL)
SSHSAP1: \$34.71

(2.5 GAL)
SSHSAP2.5: \$83.10

M-Flex Silicone Sealant

Use our clear, black, or gray RTV silicone to seal fireplace inserts, stoves, or flashings. They are heat resistant to 400°F RTV. Red silicone is heat resistant up to 500°F, 650°F intermittently. Adheres to glass, metal, most plastics, fiberglass, aluminum, wood, brick, and slate. Also prevents corrosion to copper or galvanized chimney flashings.

CLEAR
NCSC: \$11.94

BLACK
NCSE: \$11.94

GRAY
NCSE: \$11.94

RED HIGH TEMP
NCSE: \$11.94



SaverSystems Crack & Joint Sealant (FORMERLY CRACKMAGIK)

Stop leaks through brick and mortar with Crack & Joint Sealant. This brushable sealant seals cracks up to 1/8" wide on brick faces and at mortar or brick joints. It dries to a clear, translucent milky film in several hours and cleans up easily with soap and water. One half gallon container will treat mortar joints surrounding approx. 550 standard size bricks or approx. 100 sq. ft. of wall surface.



(1/2 GAL)
SSCM: \$136.79

Sealants & Cement Repair

IPC Furnace Cement

A great way to bond metal to metal, metal to masonry, or masonry to masonry. When applied properly it resists shrinking, cracking, and sagging. This is a pre-mixed cement, gray in color, available in a 2 gallon bucket. Apply it up to 1/4" maximum thickness, withstands temperatures to 3000°F. Can be applied at temperatures below 32°F.



1 GAL
IPC: \$19.70

2 GAL
IPC2: \$34.14

5 GAL
IPC5: \$83.85

Rutland Black Furnace Cement

This pre-mixed cement has been the benchmark Furnace Cement for over 90 years. Seals joints smoke and gas tight. Use to bond and seal metal to metal or masonry to metal joints under 1/8" or to install or reset furnaces or oil burners. Temperature rating: 2200°F. (Does not contain asbestos.) Requires heat to cure, may be painted once heat cured.

CARTRIDGE
64C: \$5.16

PINT (16 OZ)
64: \$6.71

QUART (32 OZ)
65: \$10.83



Rutland Dry Mix 211

Dry mix cement, just add water. This refractory mortar mix meets or exceeds all the requirements of the NFPA. Use to join or repair masonry flue tile or as a parge coating for building fireboxes and building masonry flue liners. Coverage: 10 lb covers 1,268 sq. in. 1/8" thick or 50 clay tiles. Temperature rating: 2550°F. Not for outdoor use. Does not require heat to cure. Acid resistant. Dark gray color, may be painted once dry.

PAIL (10 LB)
RU211: \$28.86



Rutland Refractory Cement 611

Pre-mixed cement for masonry to masonry repairs 1/8" to 1/4" thick. Use to set, coat or repair firebrick in fireboxes. Temperature rating: 2000°F. Requires heat to cure. Buff color, may be painted once heat cured.

(1 GAL)
RU611: \$34.49



Rutland Castable Refractory Cement 601

Dry Mix cement, just add water. Sets and dries as hard as firebrick. Use to cast custom shapes, replace worn-out firebrick or fill large holes in masonry firebox or as a solid stone bed. May also be used to build or repair outdoor fire pits. For outdoor use, temperature rating: 2200°F. Does not require heat to cure, minimum 24 hr dry time. Gray color, may be painted when dry. 12 1/2 lbs casts a block 12" x 12" x 1 1/2".

(25 GAL)
RU601: \$59.27



Rutland Stove Gasket Cement 77

The original. Use to Adhere all types of gasket materials to airtight stoves and make metal to metal or metal to masonry repairs. Temperature rating: 2000°F. Requires heat to cure. Black.

SQUEEZE TUBE (2.3 OZ)
77: \$4.90



Rutland Stove Gasket Cement 77E & 78

The perfect easy squeeze cement for quick gasket repairs. Use to adhere fiberglass gasket to cast iron and steel. Temperature rating: 2000°F. Requires heat to cure. Black.

SQUEEZE TUBE (2.3 OZ)
77E: \$4.63

CARTRIDGE (10.3 OZ)
78: \$5.39



National Chimney

Chimney Top Adhesive

10.5 oz. cartridges, used to secure multi-flue caps to the crown. Exterior use only.

(10.5 OZ)
NCCTA: \$8.41



SaverSystems **CrownPrep**

For use as a bonding coat on difficult to treat chimney crowns, CrownPrep will insure that your crown repairs will adhere and last.

(1.5 GAL)
SSCP: \$34.59



Concrete & Masonry Patch

A weather-resistant mortar and patching material for use in repairing broken mortar in chimneys, steps, windowsills, sidewalks and foundations. May be applied at temperatures below freezing if cartridge is warmed for gunning. Dries to a hard, tough weather-resistant finish in a natural concrete color.

(10.3 OZ)
89: \$7.14



Super 3000 Cement

A premium quality super duty grade mortar which has become an industry standard. Use this to bond masonry to masonry, to set firebrick or parge new smoke chambers. This is an air/heat setting mortar that can withstand temperatures up to 3000°F. Super 3000 cement covers an average of 5 sq. ft. per gallon when applied at 1/8" to 1/4" thickness. Available in two types, Parging is thicker, containing grit and troweling has a brick setting consistency.

PARGING (55 LB)
SUPER3000P: \$89.65

TROWELING (55 LB)
SUPER3000T: \$82.84



No. 7 Wet or Dry Roof Patch

All weather formula promotes adhesion and sealing to asphalt, composition, metal roofing and masonry surfaces. Use to patch worn roofing, seal flashing, gutters, downspouts and eaves. Seal around ventilators and skylights. Use around cornices and roof edges.

*Limited Availability

(10.3 OZ)
510: \$2.63



WHY CUSTOMERS LOVE NATIONAL CHIMNEY

“ The original creosote remover was a game changer when it first came out. **I did not know could be improved upon, but here we are! The workability of this product is amazing.** In the past when using a product like this it was a mad dash to get it applied once mixed. The fight was getting it applied before it started to harden. This version has a much more user friendly working time to applicate. Like every product National makes, it simply does what it says it will do.

- Tommy Nelms, Sweeps and Ladders LLC

PriorFire Retrofit

HeatShield® **PriorFire® Retrofit** Fireplace System

SIZE OPTIONS



The HeatShield® PriorFire Retrofit Fireplace System (patent pending) is a lab tested, field proven, engineered fireplace. Because of its unique shape, materials, and "Air Wing" over-fire air injection system, it produces more heat, fewer emissions, and a tall "fun to watch" flame when compared to a traditional masonry fireplace.

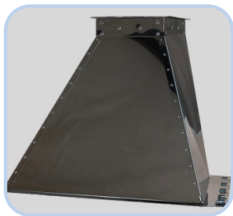

PriorFire Smoke Dome

The PriorFire Smoke Chamber Dome makes it easy to transition the PriorFire Retrofit to an 8" liner. It's made from durable 20ga 304 series stainless steel and only weighs 27 lbs. Because of its compact size, less demo work is needed when compared to other retrofit smoke chamber domes. Insulation wrap & stainless steel liner not included.

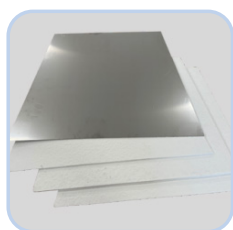

Hearth Floor Reduced Clearance Insulation Kit

The Hearth Floor Reduced Clearance Insulation Kit provides additional materials and insulation that can be added to the existing insulation and floor components when the existing hearth floor is less than 4" and greater than 2 1/2". It is UL Listed Zero-inch clearance to combustibles with 2 1/2" masonry floor.

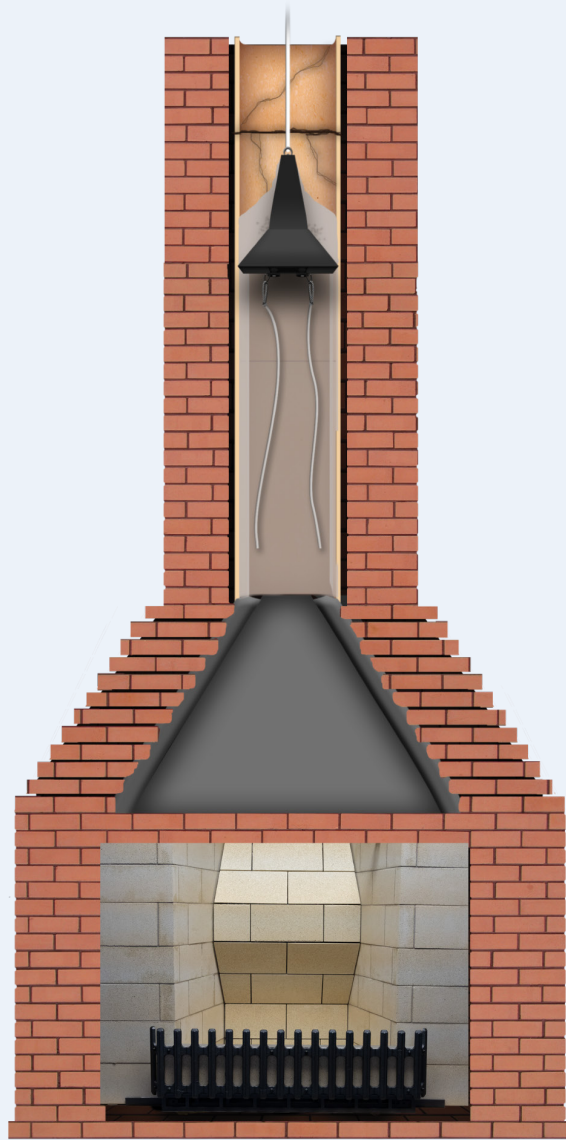

PriorFire Retrofit Fireplace Original	SSPFRF	\$3,799.00
PriorFire Retrofit Fireplace XL	SSPFRFXL	\$4,099.00
PriorFire Retrofit Fireplace XLT	SSPFRFXLT	\$4,399.00
P-24 Smoke Dome	SSPFSD	\$779.00
P-33 (XL) Smoke Dome	SSPFSDXL	\$815.00
Hearth Floor Reduced Clearance Insulation Kit	SSPFHIK	\$194.97

Brushes

CHIMNEY BRUSH CONNECTION CHART

USE THIS BRUSH OR TOOL	WITH THIS ROD	& THIS ADAPTER
ROUND WIRE THREADED (MS)	<ul style="list-style-type: none"> ★ 59F (Heavy Duty Black Fiberglass Rod) ★ 60 (Heavy Duty Yellow Fiberglass Rod) ★ 58F (Light Duty Brown Fiberglass Rod) ★ PF (Proflex Poly Rod) ★ ButtonLok™ Rod 	<ul style="list-style-type: none"> ★ No adapter needed ★ No adapter needed. ★ 1438 (1/4" to 3/8" adapter) ★ AWPP1770 (female to female adapter) ★ AWP2238
FLAT WIRE THREADED (MSF)	<ul style="list-style-type: none"> ★ 59F (Heavy Duty Black Fiberglass Rod) ★ 60 (Heavy Duty Yellow Fiberglass Rod) ★ 58F (Light Duty Brown Fiberglass Rod) ★ PF (Proflex Poly Rod) ★ ButtonLok™ Rod 	<ul style="list-style-type: none"> ★ No adapter needed. ★ No adapter needed. ★ 1438 (1/4" to 3/8" adapter) ★ AWPP1770 (female to female adapter) ★ AWP2238
SWEEPS ALL BRUSH (PF)	<ul style="list-style-type: none"> ★ 59F (Heavy Duty Black Fiberglass Rod) ★ 60 (Heavy Duty Yellow Fiberglass Rod) ★ PF (Proflex Poly Rod) ★ ButtonLok™ Rod 	<ul style="list-style-type: none"> ★ PF1780 (male to female adapter) ★ PF1780 (male to female adapter) ★ No adapter needed ★ AWP2210
POLY BRUSH (PB)	<ul style="list-style-type: none"> ★ 59F (Heavy Duty Black Fiberglass Rod) ★ 60 (Heavy Duty Yellow Fiberglass Rod) ★ 58F (Light Duty Brown Fiberglass Rod) ★ PF (Proflex Poly Rod) ★ ButtonLok™ Rod 	<ul style="list-style-type: none"> ★ No adapter needed. ★ No adapter needed. ★ 1438 (1/4" to 3/8" adapter) ★ AWPP1770 (female to female adapter) ★ AWP2238
PROFLEX TOOLS (PF)	<ul style="list-style-type: none"> ★ 59F (Heavy Duty Black Fiberglass Rod) ★ 60 (Heavy Duty Yellow Fiberglass Rod) ★ PF (Proflex Poly Rod) ★ ButtonLok™ Rod 	<ul style="list-style-type: none"> ★ PF1780 (male to female adapter) ★ PF1780 (male to female adapter) ★ No adapter needed ★ AWP2210
DUCT CLEANING BRUSH (PBX)	<ul style="list-style-type: none"> ★ 59F (Heavy Duty Black Fiberglass Rod) ★ 60 (Heavy Duty Yellow Fiberglass Rod) ★ 58F (Light Duty Brown Fiberglass Rod) ★ PF (Proflex Poly Rod) 	<ul style="list-style-type: none"> ★ No adapter needed. ★ No adapter needed. ★ 1438 (1/4" to 3/8" adapter) ★ AWPP1770 (female to female adapter)
U BRUSH (47N2)	<ul style="list-style-type: none"> ★ 58F (Light Duty Brown Fiberglass Rod) ★ 59F (Heavy Duty Black Fiberglass Rod) ★ 60 (Heavy Duty Yellow Fiberglass Rod) 	<ul style="list-style-type: none"> ★ No adapter needed. ★ 1438 (1/4" to 3/8" adapter) ★ 1438 (1/4" to 3/8" adapter)
QUICK CONNECTS	<ul style="list-style-type: none"> ★ 59F (Heavy Duty Black Fiberglass Rod) ★ 60 (Heavy Duty Yellow Fiberglass Rod) 	<ul style="list-style-type: none"> ★ No adapter needed ★ No adapter needed
PELLET STOVE BRUSH (PS)	<ul style="list-style-type: none"> ★ 25P5 (Pellet Rod) 	<ul style="list-style-type: none"> ★ No adapter needed
PROKLEEN TOOLS (WO & WRL)	<ul style="list-style-type: none"> ★ WO (ProKleen Steel Rods) ★ Enforcer Steel ButtonLok™ Rod 	<ul style="list-style-type: none"> ★ No adapter needed ★ AWP2405
CHIM SCAN	<ul style="list-style-type: none"> ★ 59F (Heavy Duty Black Fiberglass Rod) ★ 60 (Heavy Duty Yellow Fiberglass Rod) 	<ul style="list-style-type: none"> ★ No adapter needed ★ No adapter needed
VIPER	<ul style="list-style-type: none"> ★ ButtonLok™ Rod 	<ul style="list-style-type: none"> ★ AWP2240V

If a rod is not listed with a brush or tool, it means that a connection is not possible or we do not carry any adapter that would allow for that type of connection.

A. W. Perkins

Round Wire Brushes

The 22ga round wire is twisted, providing an aggressive brush, available in three shapes.

Use these adapters to attach your threaded & round wire brushes to BL rods:

ROUND WIRE = AWP2238

FLAT WIRE = AWP2238

SWEEPS ALL BRUSH = AWP2210

POLY = AWP2238

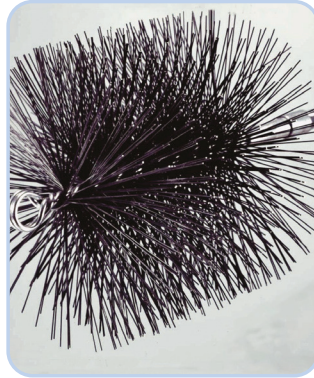

A. W. Perkins

Flat Wire Brushes

Flat, galvanized wire provides aggressive cleaning, available in three shapes.



ROUND

DIMENSIONS	BUTTONLOK™	3/8" PT CONNECTOR
5" DIA	AWPM5B \$34.76	AWPM5 \$31.66
6" DIA	AWPM6B \$35.60	
7" DIA	AWPM7B \$40.31	
8" DIA	AWPM8B \$41.06	AWPM8 \$37.77
9" DIA	AWPM9B \$42.20	
10" DIA	AWPM10B \$44.67	
11" DIA	AWPM11B \$45.49	
12" DIA	AWPM12B \$48.71	
14" DIA	AWPM14B \$51.71	
8" DIA	AWPMF8B*	

*Limited Availability

SQUARE

DIMENSIONS	BUTTONLOK™	3/8" PT CONNECTOR
6" X 6"	AWPM66B \$48.40	AWPM66 \$42.69
7" X 7"	AWPM77B \$50.41	
8" X 8"	AWPM88B \$52.77	AWPM88 \$48.00
9" X 9"	AWPM99B \$54.19	
10" X 10"	AWPM1010B \$56.79	
11" X 11"	AWPM1111B \$60.24	
12" X 12"	AWPM1212B \$62.06	
14" X 14"	AWPM1414B \$66.17	
7" X 7"	AWPMF77B*	AWPM77* \$50.41
8" X 8"	AWPMF88B*	AWPM88* \$48.00
12" X 12"	AWPMF1212B*	

*Limited Availability

RECTANGLE

DIMENSIONS	BUTTONLOK™
6" X 10"	AWPM610B \$59.87
7" X 11"	AWPM711B \$66.31
8" X 12"	AWPM812B \$67.83
9" X 13"	AWPM913B \$61.53
10" X 14"	AWPM1014B \$69.54
11" X 15"	AWPM1115B \$72.54
12" X 16"	AWPM1216B \$75.16
7" X 11"	AWPMF711B* \$94.10
8" X 12"	AWPMF812B* \$96.59

*Limited Availability

Brushes

A. W. Perkins

Round Poly Brushes

Stiff black polypropylene bristles make it resistant to acids in coal, gas, and oil. Use less aggressive .050" medium poly for use on zero clearance fireplaces.



	.075" BUTTONLOK™	.050 BUTTONLOK™	3/8" PT CONNECTOR
5"	AWPP5B \$27.50	AWP50P5B \$27.27	AWPP5 \$21.43
6"	AWPP6B \$28.03	AWP50P6B \$27.81	AWPP6 \$23.20
7"	AWPP7B \$30.04	AWP50P7B \$29.90	AWPP7 \$24.99
8"	AWPP8B \$31.03	AWP50P8B \$30.87	AWPP8 \$25.16
9"	AWPP9B \$33.94	AWP50P9B \$33.79	AWPP9 \$26.31
10"	AWPP10B \$34.85	AWP50P10B \$34.69	AWPP10 \$27.63

Round Duct Brush



This brush is useful for quick cleaning of soot and loose debris in larger chimneys. 16" dia. nylon brush will work best in 12" to 14" flues. Rugged, stiff center spindle and 3/8" NPT connector.

ROUND DUCT
AWP50N16: \$63.17

Noodle Brush

This flexible handled brush can be bent for cleaning smoke chambers, heat tubes, and pellet stove heat exchangers.



NOODLE
AWP2705: \$12.51

Smoke Chamber Brushes

This "designed for spinning" wood center brush with 8" long bristles stick nearly straight out when at rest. When spun on the Flex rods, the 8" strands fan out to reach corners of the smoke chamber. Reverse to walk brush back and forth. Available with yellow .040" bristles and stiffer black .055" bristles.

MEDIUM
AWP6734B: \$86.00

STIFF
AWP6735B: \$86.00



Wood Center Brushes

This brush is used to quickly sweep soot and loose debris in fireplace and oil flues. The rounded nose on the wood center with short brush height makes for a very maneuverable brush that navigates offsets with ease. It has a universal female thread.

6"
AWPP36: \$23.13

8"
AWPP38: \$24.90

12"
AWPP312: \$30.26

16"
AWPP316: \$34.49



Buttonflex Brushes

Use the brush to clean loose soot from wood, coal and oil flues or for cleaning dampers of zero-clearance fireplaces. This brush has a distinct wood center and floppy bristles. (Sweeps All Brush has threaded connection; ButtonFlex Brush has the ButtonLok™.)

6"
AWPF6B: \$32.23

8"
AWPF8B: \$33.77

12"
AWPF12B: \$37.86

16"
AWPF16B: \$38.80



Rutland SweepsAll™ Brushes

SweepsAll™ Brushes have tough acid resistant nylon bristles for use on masonry or metal flues. The brushes are especially suited to cleaning offset chimneys and flues relined with M-Flex pipe where creosote is not a problem. Soft floppy

bristles allow the brush, regardless of size, to fit most standard flues and will not damage or score liners. Brushes have Torque Lock Connectors. Use these brushes with ProFlex™ rods.



8"
PFT8TL: \$23.41

12"
PFT12TL: \$27.81

16"
PFT16TL: \$32.90

*Limited Availability

Pellet Stove Brushes & Rod

Poly Rod - designed to easily maneuver through 30" and 45" offsets. 0.250" Dia, 1/4"-20 threading, gray.

Pellet Stove Brushes - made with poly bristles, heavy duty ball tip guides brushes through narrow offsets and bends.

Fits PS Series brushes only. 1/4"-20 thread, use with 25P5 rod.

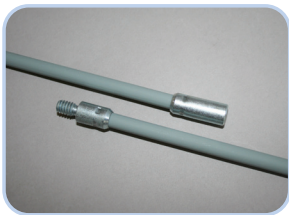

5' ROD
25P5: \$12.81

3" ROUND BRUSH
PS3: \$10.01

4" ROUND BRUSH
PS4: \$12.71

Wood Handle Wire Duster

WIRE DUSTER
AWP41372: \$8.03



Pellet Stove & Dryer Vent Brush Assembly

Designed to clean both pellet stove vents and dryer vents. Brushes can easily navigate a sharp turning radius without getting caught in elbows. Brush filament is 0.020" poly. 20' attached flexible handle/rod for very light cleanings.

3" BRUSH ASSEMBLY + 20" HANDLE
RU17419: \$18.02

4" BRUSH ASSEMBLY + 20" HANDLE
RU17420: \$18.63

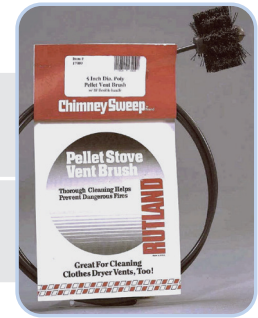

A. W. Perkins Rotary Brush Kit

This dryer vent kit comes in a soft sided caddy. The 25' kit contains 8 - 5/16" diameter x 3 ft rods, starter rod, drill adapter, and 4" brush with a 10" spring leader rod.

The 35' kit includes 6 - 5/16" diameter and 3/8" rods, starter rod, and 4" brush with spring leader.



DRYER VENT CLEANING ASSEMBLY W/BUTTONLOK™

25' ROTARY BRUSH KIT (INC. 8 - 5/16" RODS, STARTER ROD, 4" BRUSH) **AWP5185: \$399.00**

35' ROTARY BRUSH KIT (INC. 6 - 5/16" AND 6 - 3/8" RODS, STARTER, 4" BRUSH) **AWP5186: \$499.00**

REPLACEMENT PARTS

4" BRUSH WITH SPRING LEADER **AWP5168: \$45.99**

DRILL ADAPTER FOR DRYER VENT RODS **AWP2715: \$28.40**

DRYER VENT BUTTONLOK™ WHITE NYLON ROD 3 FT X 5/16" DIA. **AWP5163: \$31.57**

ROD 3 FT X 3/8" DIA. **AWP3803: \$32.53**

Counter Duster Brush

COUNTER DUSTER
AWP728: \$14.34



Cleaning & Maintenance Tools

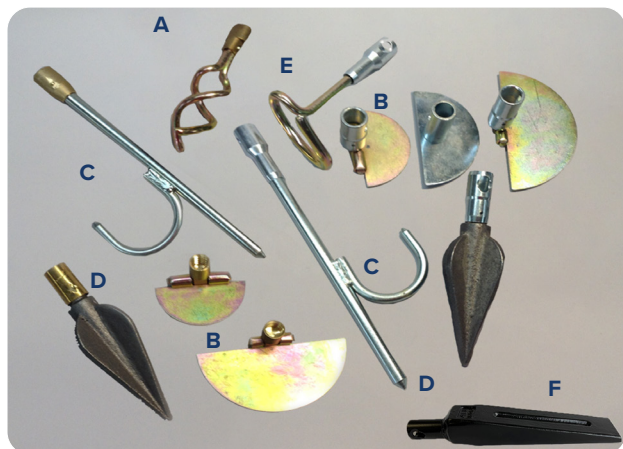

A. DOUBLE WORM SCREW

Use this for destroying or removing unwanted bird nests and large accumulations of soot found in chimneys.

DOUBLE WORM SCREW	AWPP1730: \$19.19
-------------------	-------------------

B. SCRAPERS

Half-Round Hinged Scraper designed to clean soot and creosote, fallen bricks, and mortar pieces, as well as free blockage-like accumulations of soot found in chimneys.

5" FIXED SCRAPER W/ BUTTONLOK™	AWPP1755B: \$45.73
4" HINGED SCRAPER	AWPP1764: \$21.57
4" HINGED SCRAPER W/ BUTTONLOK™	AWPP1764B: \$50.71
6" HINGED SCRAPER	AWPP1766: \$22.23
6" HINGED SCRAPER W/ BUTTONLOK™	AWPP1766B: \$53.04

C. HARPOON

Another way to remove foreign objects, as well as for chipping away tough glaze build up.

HARPOON	AWPP1720: \$40.33
HARPOON W/BUTTONLOK™	AWPP1720B: \$49.35

D. BORING TOOL

Can be used to help with flue tile removal. Provides heavy impact for penetrating stubborn obstructions.

BORING TOOL	AWPP1740: \$57.34
BORING TOOL W/BUTTONLOK™	AWPP1740B: \$63.50

E. RETRIEVAL TOOL

This heavy-duty tool is bent with a 3/4 rotation to allow it to be rotated into obstructions or debris to help break them up. It's also handy when attempting to retrieve brushes lodged in the flue.

RETRIEVAL TOOL W/BUTTONLOK™	AWPP1745B: \$63.50
RETRIEVAL TOOL W/BROOM TREAD	AWPP1745: \$57.34

F. CHISEL

PterodacTILE Wedge/Chimney Chisel w/ButtonLok™ *Female*

CHISEL W/BUTTONLOK™	AWPP1726B: \$59.00
---------------------	--------------------

Chamber Ease

National Chimney's Chamber Ease is a tool to scrape debris off hard-to-reach smoke shelves.

CHAMBER EASE
NCCE: \$35.38



PterodacTILE Mini-T Tile Extractor

Lighter weight tool to be used inconjunction with our Large T1, jaws open wide to grab objects up to 4" across, cast aluminum body is lighter for better control when way down the chimney, replaceable polyurethane coated jaws, two operation modes allows precise control to pick up very small objects or full tiles, including round tiles. ButtonLok™ double connector works with existing ButtonLok™ Rods. Replaceable urethane coated jaws grip tightly. Swivel winch connector allows attachment of winch to assist heavy lifts.

PTERDAC TILE MINI-T TILE
EXTRATCOR/SETTER SMALL
AWPT2: \$603.90



Guide Ball

BUTTONLOK GUIDE BALL
AWP2721: \$23.39



Noise Maker

BUTTONLOK NOISE MAKER
AWP2718: \$23.87



Nest Claw

(attaches to nylon rods)

BUTTONLOK NEST CLAW
AWP2716: \$30.23



The Wizard System

Unique patented rotary action safely and effectively removes thin layers of accumulated glazed creosote and crust. The loops wipe the sides and corners of clay flue tiles to remove buildup. It gets down to the liner in minutes. It also scores heavier concentrations of surface glaze for faster penetration of liquid creosote remover treatments.

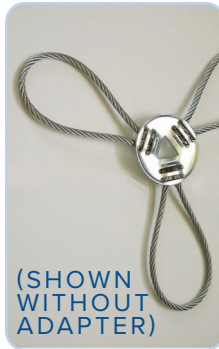

WIZARD ASSEMBLY (W/ TORQUE LOCK CONNECTION INCLUDES: 14" LOOP, CONNECTOR TO JOIN THE 2" ROD TO THE LOOP ASSEMBLY.)	WRL100T: \$74.42
WIZARD ASSEMBLY (W/ 14" LOOP PKMTFL & WRLADPT ADAPTERS. FITS PROKLEEN™ RODS ONLY.)	WRL100RK: \$85.74
14" LOOP ASSEMBLY (W/ U-BOLT REPLACEMENT)	WRL14: \$33.91
24" LOOP ASSEMBLY (W/ U-BOLT REPLACEMENT)	WRL24: \$34.29
PROFLEX LOOP ADAPTER	WRLADP1: \$36.02

*Limited Availability

A. W. Perkins

Snagless Whip Heads

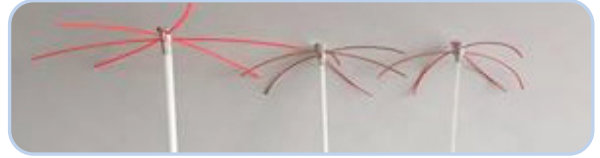

SLICK ROD 1/4" W/ SNAGLESS WHIP HEAD

AWP2503WH
\$44.10

Super flexible rod will navigate 3" pellet vents, outdoor boiler fire tubes and high velocity HVAC ducts. 'No tool' strand replacement. (Small ButtonLok™)

SLICK ROD 5/16" W/ SNAGLESS WHIP HEAD

AWP5163WH
\$49.69

Ideal for 4" pellet and dryer vents. 10" whip strands, 'No tool' replacement. Use with EZ Driver adapter (adapter section). (Small ButtonLok™)

SLICK ROD 7/16" W/ SNAGLESS WHIP HEAD

AWP7163WH
\$54.00

Ideal for liner and Class A cleaning. 3 - .155 x 12" strands, 'No tool' replacement. (Small ButtonLok™)

WHY CUSTOMERS LOVE NATIONAL CHIMNEY

66

I have used National Chimney for over 15 years and I wouldn't trust anyone else with my customer's needs. **They are hands down the best manufacturer in the industry. They provide quality materials at a competitive price, but that's just the start.** Their customer service is top notch, from their responsive office staff to their supportive sales reps and their attentive tech team always know we have a helping hand with whatever we need. Their fleet of designated delivery trucks make regular deliveries so we never have to guess when a freight truck is coming. If you want to use the best in the business, look no further than National Chimney.

- John Ceasar, *Caesar Chimney*

Cleaning & Maintenance Tools

A. W. Perkins Medusa Super Scrub Power Sweeping Whip

A totally new construction whip for rotary power sweeping of chimneys using the large ButtonLok™ connector with 11 strands of .155" diameter shark tooth whip line. The Super Scrub Whip is unsurpassed for cleaning chimneys gently yet effectively. Passes through dampers easily then expands out to scrub the flue removing soot and flaky creosote. It's easily adjusted to give just the right amount of scrubbing. The guide ball on front helps negotiate offsets.

SWEEPING WHIP
AWP7265: \$75.60

REFILL STRANDS
AWP726511: \$9.40

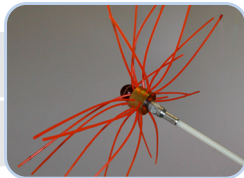

A. W. Perkins Cable Whip

The A. W. Perkins cable loop with ButtonLok™ connector is used when power sweeping glazed masonry chimneys. Unlike other loops, it can be restrung with cable sourced locally. A 6' cable makes a 14" loop, and 12' makes a 24" loop.

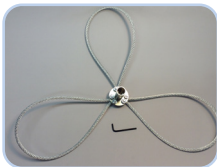

CABLE WHIP W/ BUTTONLOK™
AWP7255: \$75.60

A. W. Perkins Stinger Whip

Use this .155" diameter line for fast rotary cleaning of soot or dry creosote deposits. Tips get into corners of flues up to 12" x 12" (part of the ButtonLok™ system).



STINGER WHIP W/ BUTTONLOK™ ADAPTER AWP7321
AWP7235: \$68.00

REPLACEMENT WHIP
AWP7235-9: \$8.36

A. W. Perkins Mini Medusa

For soot and flaky creosote in smaller than 7" flues.

MINI MEDUSA	AWP7260: \$71.40
REFILL STRANDS	AWP726011: \$7.30

A. W. Perkins Large Missile Whips

Aluminum Whip Head with integrated ball top and 'no tool' line change. Strung with either 12" or 24" .055" whip line or set up as creosote 'scratcher' with 1/8" steel cable. Replace steel cable for each job for best performance. Scratcher version not for lightweight liners.



ALUM MISSILE WHIP 12" W/ LARGE BUTTONLOK™ .6"-12"X .155 STRANDS	AWPRO13: \$46.71
ALUM MISSILE WHIP 14" W/ LARGE BUTTONLOK™ .6"-24"X .155 STRANDS	AWPRO14: \$49.14
SCRATCHER ALUM MISSILE WHIP 10" W/ LARGE BUTTONLOK™ .6"-10"X 1/8" SST STRANDS	AWPRO23: \$50.76

A. W. Perkins Missile Whip

Use the following combination for cleaning smoke pipe:

- 2 AWP7163 Rods,
- 1 AWP2730 Missile Whip
- 1 AWP2715 Drill Adapter



Missile Whip with 2 strands of 10" .155" whip material. Works great on smoke pipe.

MISSILE WHIP	AWP2730: \$39.75
DRILL ADAPTER FOR DRYER VENT RODS	AWP2715: \$28.40
NYLON FLEX ROD 4'X3/8" DIA	AWP3804: \$35.24
NYLON FLEX ROD 5'X3/8" DIA	AWP3805: \$39.38

Rutland Tile Breaker with TLC

When attached to ProKleen™ steel rods, powered by a 1/2" electric drill, these weighted tools spin in concentric circles to break out clay flue tiles quickly and efficiently.

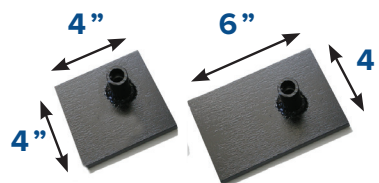

SMALL
WOWTBT44: \$32.26
LARGE
WOWTBT46: \$33.10

National Chimney Tile Breaker

This tile breaker tool removes rectangle or square flue tiles faster and easier than any other tool on the market today. Available for ButtonLok™, ProKleen and Torque Lock style rods. (This tool does not work on round flues.)



ROUND BUTTON BLUE SMALL ROUND BUTTON	NCTILEBREAKER: \$90.03
OVAL RED (FITS BUTTONLOK™)	NCTILEBREAKERBL: \$90.03
TORQUE LOCK	NCTILEBREAKERTL: \$90.03

A. W. Perkins Tile Breaker

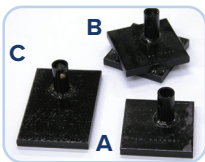

A. W. Perkins Steel Plate Tile Breaker with ButtonLok™ connector comes in three sizes: small 4" X 4", rectangle 4" X 6", and heavy duty double 4" X 4".

	SMALL A	DOUBLE B	LARGE C
OVAL BUTTONLOK™ TILE BREAKER	AWPBTB44 \$37.44	AWPBTB44H \$54.91	AWPBTB46 \$39.84
SMALL ROUND BUTTON	AWPTB44 \$40.45	AWPTB44H \$63.23	AWPTB46 \$40.97

Rod Caddies

Carry your chimney rods, attachments, tools and small brushes in these caddies.



46" L BLACK NYLON (RUTLAND)	AWS850: \$65.57
33" L BLACK NYLON POWER SWEEPING (A.W. PERKINS)	AWP7603: \$86.87
5' L BLACK NYLON POWER SWEEPING (A.W. PERKINS)	AWP7605: \$100.14
RODTECH ZIPUP 47" L (A.W. PERKINS)	AWP7615: \$100.14
WHIP HEAD COVER 18" L (USE WITH AWP7603 & AWP7605)	AWP7621 \$43.73

A. W. Perkins

Glaze Removal Chain

Rugged chain securely attached to our solid steel ButtonLok™ Adapter and Hub. Attach to Enforcer™ rods to spin away creosote—even glaze deposits.



BUTTONLOK™ GLAZE REMOVAL CHAINS FOR 8" X 8" FLUES	AWP7245: \$66.75
BUTTONLOK™ GLAZE REMOVAL CHAINS FOR 12" X 12" FLUES	AWP7245L: \$70.75

A. W. Perkins

Creosote Removing Chains

Removes creosote by spinning in masonry or heavy wall stainless liners. The traditional chain whip with small round button connector. It's compatible with AWP and AWP rods.



REMOVING CHAINS
AWPCW16: \$75.83

Cleaning & Maintenance Tools

A. W. Perkins **New Sweep Start-Up Kits**

FOR POWER SWEEPING STOVES AND INSERTS		
Product Number	Description	Suggested Qty
AWP1230S	Rod 1/2" x 3' Nylon Slick ButtonLok™ leader rod	12
AWP2258	ButtonLok™ drill adapter 3/8" shank	1
AWP2259	ButtonLok™ drill adapter heavy duty 1/2" shank	1
AWP7260	Mini Medusa SuperScrub™ power sweeping whip with large ButtonLok™	1
AWP7260-11	Refill for Mini-Medusa SuperScrub™ above	2

FOR POWER SWEEPING MASONRY FLUES		
Product Number	Description	Suggested Qty
AWP8752	Rod 7/8" x 2' ButtonFlex™ black poly rod. (Use with the AWP6735B)	1
2AWP5830	Rod 5/8" x 3' Slick nylon white rod	12
AWP6735B	Smoke chamber brush with Large ButtonLok™, stiff black	1
AWP2258	ButtonLok™ drill adapter 3/8" shank	1
AWP2259	ButtonLok™ drill adapter heavy duty 1/2" shank	1
AWP7255	Cable loop whip with ButtonLok™ female for deglazing	1
AWP7265	SuperScrub™ Medusa whip head with ButtonLok™ female	1
AWP726511	Refill for SuperScrub™ Medusa above	2
AWP7245	Chain whip set with ButtonLok™ adapter for up to 8 x 8 flues	1
AWP725L	Large chain whip set with ButtonLok™ adapter for up to 12 x 12 flues	1
AWPP1745B	Retrieval tool ButtonLok™	1

Includes: 5/8" Slick Nylon rods for power sweeping fireplaces or larger diameter ducts, SuperScrub™ Medusa, deglazing tools, retrieval tool for same plus short 2' rod and brush for smoke chamber cleaning.

TILE BREAKING/DEGLAZING SET		
Product Number	Description	Suggested Qty
AWP2259	ButtonLok™ drill adapter heavy duty 1/2" shank	2
AWPP7530	Rod 3/4" x 3' Nylon Slick	12
AWP7255	Cable loop whip with ButtonLok™ female for deglazing	1
AWP7245	Chain whip set with ButtonLok™ adapter for up to 8 x 8 flues	1
AWP7245L	Large chain whip set with ButtonLok™ adapter for up to 12 x 12 flues	1
AWPBTB44	Small 4" x 4" ButtonLok™ tile breaker	1
AWPBTB44H	Double offset heavy duty ButtonLok™ tile breaker	1
AWPP1720B	Harpoon with ButtonLok™ connector	1
AWPP1726B	Chisel 1" with ButtonLok™ connector	1
AWPP1740B	Boring tool with ButtonLok™ connector	1
AWPP1755B	5" Fixed scraper with ButtonLok™ connector	1
AWPP1764B	4" Hinged scraper with ButtonLok™ connector	1
AWPP1766B	6" Hinged scraper with ButtonLok™ connector	1

Rutland **Adapters & Rods**

	ROD SIZE	3/8" THREAD	TORQUE LOCK
BLACK FIBERGLASS HEAVY DUTY ROD	.440" DIA 4'	59F4* \$10.90	
	.440" DIA 5'	59F5* \$11.34	
YELLOW FIBERGLASS SUPER DUTY ROD	.480" DIA 6'	60X6* \$12.48	60XT-6TL* \$21.81
PROFLEX™ POLY ROD	3' X 3/4" DIA		
	5' X 7/8" DIA		PFT-78-5TL* \$25.35
PROKLEEN™ STEEL STARTER ROD	2" X 1/4" DIA		57ST-2TL* \$12.14
STEEL EXTENSION ROD	2 1/2' X 1/4" DIA		57ST-25TL* \$20.13
	5' X 1/2" DIA		57ST-50TL* \$21.01

* Limited Availability



Fiberglass Rods

Black Fiberglass Rods

Commercial grade, heavy duty, black, .440" Dia. Fits Master Sweep™ chimney brushes. Note: not for spinning.

Yellow Fiberglass Rods

Commercial grade, super duty, yellow .480" Dia. Fits Master Sweep™ Chimney Brushes.

ProFlex™ Poly Rods

Super flexible polypropylene, choose for cleaning from below and when going through sharp bends, offsets, breeches or thimbles. Rust-proof fittings fit flush with rod. Not for spinning.

ProKleen™ Steel Rods

When steel rods are used with a 1/2" electric drill, the TLC fittings insure tools may be rotated in either direction without separation.



PROFLEX™ POLY RODS WITH 3/8" THREAD AND TORQUE LOCK CONNECTION



PROKLEEN™ ROD WITH TORQUE LOCK CONNECTION



2" PROKLEEN™ STARTER ROD

Rutland **Adapters**

*Limited Availability

1	3/8" FEMALE/TLC FEMALE	3/8" NPT BRUSH	TLC ROD	38FTFTL: \$5.92*
2	3/8" MALE/TLC MALE	TLC BRUSH	3/8" NPT ROD	38MTMTL: \$6.48*
3	PROFLEX™ MALE/TLC FEMALE	SWEEPSALL	TLC ROD PFT SERIES	PFMTFTL: \$9.94*
4	PROFLEX™ FEMALE/TLC MALE	TLC SWEEPSALL	PROFLEX™ ROD PF SERIES	PFFTMTL: \$11.70*
5	PROKLEEN™ MALE/TLC FEMALE	PROKLEEN™ TOOLS	TLC PROKLEEN™ ROD 57ST SERIES	PKMTFTL: \$11.45*
6	PROKLEEN™ FEMALE/TLC MALE	TLC PROKLEEN™ TOOLS	PROKLEEN™ ROD 57S SERIES	PKFTMTL: \$11.75*



1



2



3



4



5



6



Use to connect 3/8" NPT rods to tools with 1/4" fittings.

Cleaning & Maintenance Tools

A. W. Perkins ButtonLok™ Adapters

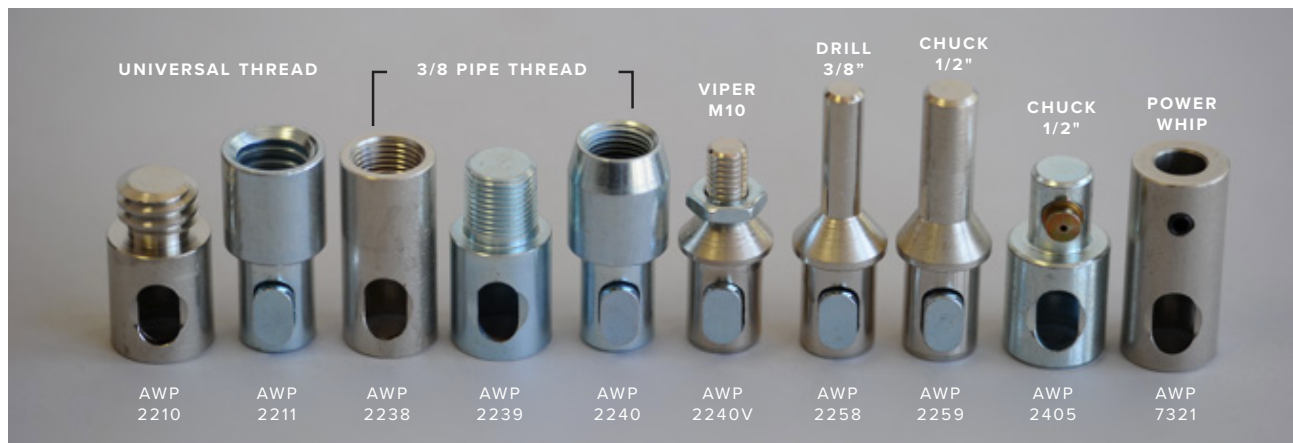

A. W. Perkins ButtonLok™ Adapters

UNIVERSAL THREAD	AWP2210: \$23.17
UNIVERSAL THREAD	AWP2211: \$24.32
3/8" PIPE THREAD	AWP2238: \$23.17
3/8" PIPE THREAD	AWP2239: \$23.17
3/8" PIPE THREAD	AWP2240: \$24.32
VIPERM10	AWP2240V: \$27.04
DRILL 3/8"	AWP2258: \$30.74
CHUCK 1/2"	AWP2259: \$30.74
CHUCK 1/2"	AWP2405: \$30.25
POWERWHIP	AWP7321: \$30.33

A. W. Perkins Adapters



FEMALE SOCKET 3/8" NPT QUICK CONNECT	AWPQS: \$35.27
QUICK CONNECT FEMALE SOCKET PLUG 3/8" NPT QUICK CONNECT	AWPQF: \$7.47
MALE PLUG 3/8" NPT QUICK CONNECT	AWPQM: \$6.77



3/8" NPT ADAPTERS
AWPP1780: \$10.97
AWPP1770: \$10.79

AWPP1780 AWPP1770

A. W. Perkins EZ Drivers

With new EZ Button, it self-actuates in BOTH directions. No need to depress button when connecting or disconnecting. Will not come apart when spinning, button stays locked.

EZ DRIVER ADAPTER SPECIAL SMALL MALE BUTTONLOK™	AWP2715EZ: \$28.40
EZ DRIVER ADAPTER 3/8" SHANK SPECIAL LARGE MALE BUTTONLOK™	AWP2258EZ: \$31.83
EZ DRIVER ADAPTER 1/2" SHANK SPECIAL LARGE MALE BUTTONLOK™	AWP2259EZ: \$31.83



A. W. Perkins Rods

ButtonLok™ connectors provide state of the art quick connects for power sweeping, deglazing and tile breaking. Easy to connect and disconnect speeding the sweeping process. To power sweep, connect the ButtonLok™ Drill Adapter to the rods and your choice of the various cleaning heads. A. W. Perkins also makes and sells threaded rods as shown in the chart here. Adapters allow mixing of old tools and brushes with new rods.

Black Poly Rods “Buttonflex” - with ButtonLok™ Ends

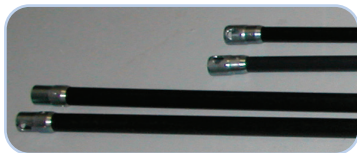

These tried and true rods are available in many lengths and two diameters. The 2' version is used with the Smoke Chamber spin brush. The 3/4" diameter

to 3' long rod is good as a more flexible leader rod or to use for smaller diameter stove and insert flues where the added stiffness is unnecessary. The 7/8" rods are stiffer to traverse longer distances or to deliver torque to the whip in larger flues without flopping around like more flexible rods.

Fiberglass ButtonLok™ Chimney Brush Rods

are .440 and .480 diameter. The rods are for use with Heavy Duty ButtonLok™ brushes. Adapters to convert old rods are available. Not for use with our drill adapter; these rods could shatter.

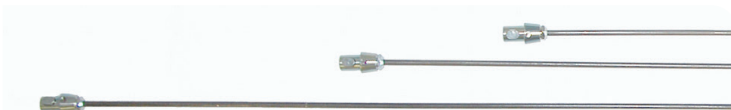
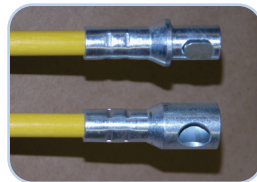

Steel Enforcer™ rods are used for rotary deglazing and tile breaking. Use with our chain or cable whips (AWP7245 or 7255) or with one of our tile breakers.

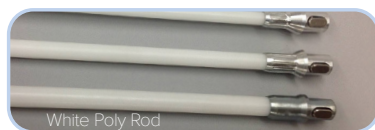

1/2" Superflex Nylon Rods

Both items are solid white rods used for stove and insert chimneys up to 8". The economical Superflex Nylon Rods are available in 3' and 5' lengths with enough flexibility to use through thimbles and clean out doors. New Slick rods are the same flexibility but the plastic is slippery, so there is less friction when multiple bends are encountered. The material also takes heat and cold better giving them a longer life and much improved cold weather performance. Slick Rods available in 3' length only. Used most frequently with Mini-Medusa, AWP7260.



	Rod Size	Oval	w/Universal Brass Thread
BLACK POLY RODS	2' X 7/8" DIA	AWP8752 \$41.97	
	3' X 7/8" DIA	AWP8753 \$42.53	
	3' X 3/4" DIA	AWP7753 \$36.97	AWPP343 \$12.74
	4' X 7/8" DIA	AWP8754 \$45.03	
	5' X 7/8" DIA	AWP8755 \$47.29	AWPP785 \$27.50
	6' X 7/8" DIA	AWP8756 \$48.61	
FIBERGLASS RODS BLACK	4' X .440" DIA	AWP444B \$35.19	
	5' X .440" DIA	AWP445B \$36.04	
	6' X .440" DIA	AWP446B \$37.63	
YELLOW RODS	32" X .480" DIA	AWP483B \$38.37	
	6' X .480" DIA	AWP486B \$45.06	3/8" AWP16072 NPT \$17.73
STEEL ENFORCER RODS	1' X 1/4" DIA STARTER	AWP1410 \$31.51	
	2.5' X 1/4" DIA	AWP1425 \$49.45	3/8" AWP17072 NPT \$26.13
	5' X 1/4" DIA	AWP1450 \$53.03	
STEEL RODS WITH SMALL ROUND BUTTON	1' X 1/4" DIA		AWPOSR10 \$22.44
	2.5" X 1/4" DIA		AWPOSR25 \$32.51
	5' X 1/4" DIA		AWPOSR50 \$35.23
NYLON SLICK RODS	3' X 5/8" DIA	AWP5830 \$46.20	
	3' X 3/4" DIA	AWP7530 \$51.46	
	3' X 7/16" DIA	AWP7163 \$36.23	
	3' X 1/2" DIA	AWP1230S \$41.63	
SUPERFLEX NYLON RODS	3' X 1/2" DIA	AWP1230 \$41.63	
	5' X 1/2" DIA	AWP1250 \$49.86	

Size 3/4" x 3' Solid Nylon “Slick” Rod For tile breaking and deglazing operations. Use instead of steel rods, as they have minimal flex. And the larger size is easier to handle than steel rods. (With crimped on fittings.) Super rugged double connection stays straight, can be used for tile breaking and chain deglazing. Compatible with single or double ButtonLocks™



SLICK ROD AWP7540D: \$53.56

Cleaning & Maintenance Tools

Wohler USA Viper Chimney Cleaning System

BELT CLIP



HANDY VIPER



REGULAR VIPER



MINI VIPER

The Viper is the ideal way to clean prefab or medium to large chimneys. Weighs only 12 lbs. Simply uncoil or retract the 50' or 65' rod. The Handy Viper is a smaller version, at only 4 lbs. You can clip it onto your belt. This is a great way to clean those small to medium sized chimneys. The Handy Viper comes with a 50' cable. The Mini Viper has 50', 4.5 mm dia. rod, and comes with a folding handle and belt clip and weighs just 2.5 lbs. Brushes not included with vipers.

VIPER 50 FT	VIPERSM: \$539.08
VIPER 65 FT	VIPER: \$556.96
HANDY VIPER	VIPERHANDY: \$473.82
MINI VIPER	VIPERMINI: \$463.99

Dome Brush

Use this nylon perlon brush to clean any of our stainless steel liners. It has an M10 thread which adapts to the large viper.

BRUSH SIZE	LINER SIZE	
7"	5"	WOH1466: \$42.82



RECOMMENDED

Always use a brush size 2" larger than the flue size.

Replacement Parts



WOH7979

REPLACEMENT KNOB & SPRING
WOH7979: \$41.84

REPAIR KIT FOR VIPER
WOH3690: \$60.79



WBVA01



VIPER ADAPTER
UJ TO MALE 10 MM
WBVA01: \$21.63

Threaded Brush (Order brush 2" larger than flue) There are three main types: PEK brush, poly perlon brush with nylon bristles, and spring-steel flat wire. The items with the M5 thread are for use with the mini viper. The M10 thread is for the large viper, handy viper, and small viper. The only M5 thread brush is a PEK brush which can be used for any of our stainless steel liners, pre-fab chimneys, dryer vent, or duct cleaning. M5 thread is for MiniViper only. The M10 threaded brushes for the large, small, and handy viper are available in all three types. The PEK and poly perlon are great for cleaning stainless steel liners, pre-fab chimneys, dryer vents, and ducts. The Spring-Steel Flat Wire threaded brush (M10 thread) is for cleaning clay flue tile or masonry chimneys.

BRUSH SIZE	LINER SIZE	PEK (M5 THREAD)	PEK (M10 THREAD)	POLY PERLON (M10 THREAD)	SPRING-STEEL FLAT (M10 THREAD)
3"	3"	WOH3803 \$35.13	NOT AVAILABLE	NOT AVAILABLE	NOT AVAILABLE
4"	4"	WOH8076 \$42.02	NOT AVAILABLE	NOT AVAILABLE	NOT AVAILABLE
6"	4"	WOH3839 \$45.86	WOH518 \$38.17	WOH545 \$31.47	WOH1360 \$32.54
8"	6"	NOT AVAILABLE	WOH315 \$41.84	WOH1413 \$35.76	WOH1368 \$34.42
10"	8"	NOT AVAILABLE	WOH316 \$43.72	WOH1415 \$38.13	WOH1376 \$37.19
12"	10"	NOT AVAILABLE	NOT AVAILABLE	WOH531 \$38.44	WOH1384 \$40.95
					
		YELLOW STRAW	YELLOW STRAW	BLACK PLASTIC 3 LAYERS	FLAT WIRE

Stars

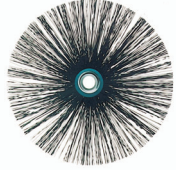
With a universal opening for all vipers, this is used to clean creosote build-up. Available in VA crimped stainless steel wire, PEK, and perlon bristles. The VA crimped star has "wavy" stainless wire bristles; therefore, it is not recommended for use on stainless steel liners. PEK and perlon stars are made of a rigid plastic material.

		PEK	POLY PERLON	VA FLAT WIRE MED HARD STAINLESS STEEL
6"	4"	WOH6904 \$33.08	WOH2743 \$23.24	NOT AVAILABLE
8"	6"	WOH6900 \$38.44	WOH1306 \$28.25	WOH1283 \$32.27
10"	8"	WOH6901 \$44.07	WOH1307 \$32.27	WOH1284 \$31.02
12"	10"	WOH6902 \$59.90	WOH1308 \$31.02	WOH1285 \$35.31
				
		YELLOW STRAW	BLACK PLASTIC	STAINLESS STEEL FLAT WIRE

Inspection & Service Equipment

The Mad Hatter 20/20 Wi-Fi

- Rugged water and air tight molded polypropylene case.
- 7" TFT-LCD active matrix monitor, 16:9 wide screen display.
- 700 line resolution auto focus, auto iris camera.
- 4 super bright LED camera head lighting with adjustable light output.
- Internal high quality power supply.
- 50' 18/4 rubber cased wire, 1 video output jack.
- Internal Wi-Fi allows pictures and video to be recorded on any Android or IOS device.
- 1 Year Warranty against defects.

**20/20 CAM
W/ VIDEO & DVR
MH2020: \$2,200.00**



A. W. Perkins Flash-Corder™

3.7 V Li-ion battery (included) charges in 4 hours with a running time of up to 3 hours. A/C charger included. Rugged aluminum housing is splash and dust resistant for daily use by chimney sweeps and service professionals for video documentation. USB 2.0 connector is sealed to protect it inside and outside the unit, cable included. For use in temperatures between 10° and 120° F. Compact size at 8" L x 2 1/4" Dia., lightweight at 9 oz.

Flashlight features:

- Spot and Flood light settings plus emergency flash
- (3) LED's with 100 lumen brightness
- Use Flood setting for close-up video up to 5" distance
- Use Spot setting for distance viewing/video.

Video Recording features:

- Date and Time stamped video
- Saves MP4 files up to 30 min. long
- Audio option
- Auto focus down to 1"
- 4GB card sealed for protection

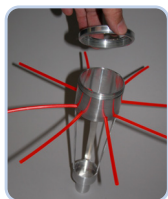

Flash-Corder Holder

Aluminum frame with large ButtonLok™ female connector. Allows use of ButtonLok™ chimney rods to push the Flash-Corder™ up or down the chimney. Threaded bezel protects leading edge of Flash-Corder™.

**FLASH-CORDER™
AWP9642: \$269.00**

**FLASH-CORDER™ HOLDER
AWP9642H: \$93.45**



VIS400 Professional Video Inspection System

Perfect for inspections while on the roof. Very bright LED lighting-selectable. Compact and easy to use, Weighs just 3 lbs. Includes carry strap and protective pouch with anti glare protection.



**VIDEO INSPECTION
WOHVIS400: \$5,687.03**

Inspection Mirror

Choose from one of these great mirrors to assist in seeing obstructions or offsets in the chimney.

- Regular Handle Mirror: 2 1/8" x 3 1/2", length 11 1/4", extends to 15 1/4"
- Long Handle Mirror: 2 1/8" x 3 1/2", length 17 1/4", extends to 27 1/2"

REGULAR HANDLE	ULK2: \$9.52
LONG HANDLE	ULK2L: \$14.06
REPLACEMENT MIRROR	ULK2R: \$1.71

Wohler USA Mirror



Wohler Mirror: 3"x 6", 8" Long extends to 40"

WOHLER MIRROR	WOH8087: \$144.83
REPLACEMENT MIRROR	WOH1119: \$60.43

Lindemann SmartScan

- SmartScan Case easily attaches to your existing rods.
- Download the App using your Apple/Android Smartphone and install your phone inside the SmartScan Case.
- Your phone wirelessly connects to your iPad/Tablet for fast image viewing, photos and video.

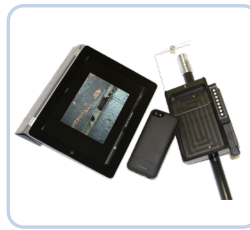

VIDEO INSPECTION SYSTEM SMARTSCAN: \$499.99

Includes phone holder and 2 Larry Lights.
Phone and tablet not included

A. W. Perkins **Ro-Vac™** Vacuums

The 1 Motor RoVac is powerful yet light at under 20 lbs. This handy vac comes with a standard 3" x 12' hose & 1 1/2" hose and accessories. Great for stove and fireplace servicing, now with a new 2-stage motor rated 110" CFM and 122" water lift. Its new SootStop pre-filter and MicroBag filter stops 99% of dust, and the HEPA filter stops what does get through. It rolls on (5) non-marking casters or can be carried. Exterior shell is available in plastic or stainless steel.

Use one, two, or all three motors depending on the vent size and air flow need with the 3 Motor RoVac. Rated at 405 CFM and 70" water column suction, this vacuum is pound for pound the most powerful vacuum available, yet quiet at only 78 db. It provides extraordinary dust collection as well as unmatched debris pickup. The new SootStop dacron pre-filter may be used to stop 98% of debris and is essential for servicing of oil or coal flues. Its large, washable micro coated bag filter stops almost all the rest of the particles in a typical dust stream, the tiny amount

remaining is stopped by the HEPA filter.

You can get your 3 Motor vacuum with a removable tank on a cart or with a fixed trolley, in either case they have 12" rear wheels (with lifetime warranty) and locking 5" front casters. Each includes SootStop dacron pre-filter, micro coated filter, HEPA cartridge filter, 3"x12' heavy duty gray hose with swivel connector, 1 1/2" x 8' hose with swivel connector and (2) 18" extension wands, 1 1/2" accessories (tool adapter, brush, crevice & floor tools) and 4" x 10' heavy duty dust hose with wear strip.

1 MOTOR W/ PLASTIC DRUM	AWP1101: \$849.00
1 MOTOR W/ STAINLESS STEEL DRUM	AWP1102: \$955.23
3 MOTOR W/ REMOVABLE PLASTIC DRUM	AWP1103-3: \$2,465.69
3 MOTOR W/ FIXED PLASTIC DRUM	AWP1105-3: \$2,350.93
3 MOTOR W/ REMOVABLE STAINLESS STEEL DRUM	AWP1107-3: \$2,523.06

SOOTSTOP DACRON PRE-FILTER <small>(FOR 3 MOTOR VACS)</small>	AWP1125: \$36.67
SOOTSTOP DACRON PRE-FILTER <small>(FOR 1 MOTOR VAC)</small>	AWP1126: \$21.69
MICROBAG FILTER <small>(FOR 3 MOTOR VACS)</small>	AWP1121: \$62.37
MICROBAG FILTER <small>(FOR 1 MOTOR VAC)</small>	AWP1122: \$57.54
HEPA FILTER <small>(FOR 3 MOTOR VACS)</small>	AWP1123: \$60.77
HEPA FILTER <small>(FOR 1 MOTOR VAC)</small>	AWP1124: \$60.77
HEAVY DUTY GRAY DUST HOSE (3"X12") <small>W/ SWIVEL CONNECTOR</small>	AWP8502S: \$132.34
FLEXIBLE METAL HOSE (4'X1 1/4")	AWP8524: \$63.53



1 MOTOR VAC WITH REMOVABLE STAINLESS STEEL DRUM



3 MOTOR VAC WITH FIXED PLASTIC DRUM



3 MOTOR VAC WITH REMOVABLE STAINLESS STEEL DRUM

Service & Safety Equipment

Ridge Hooks

These hooks fit any ladder with 12" rungs and secures it over the ridge of the roof. Available with wheels (rolling) or without (flat). Ridge Hooks can help minimize the chance of damaging your customer's roof and provide safe climbing. Price is for a single hook.

ROLLING
LLFLH-C: \$38.53

FLAT
LLFLH: \$31.62

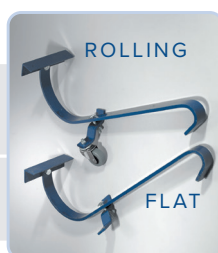

Ultimate Ridge Hooks

Ultimate Ridge Hooks are a pair of reversible, adjustable, steel brackets that straddle the roof ridge and allow you, via 2" x 8" base planks, to attach chimney/roof brackets or custom built stage on either or both sides of the ridge - without any roof penetrations. Made of powder coated, 14ga steel. Ultimate Ridge Hooks are rated for 1,750 lbs. on a 12 pitch roof. All hardware and a set-up guide included. A YouTube video is on the website: Ultimateridgehook.com.



ULTIMATE RIDGE HOOK
ULRH: \$252.00

Ladder Levelers

Xtenda-Leg™

Essential for working safely on uneven surfaces. Level a ladder in seconds with unlimited adjustment positions. Simply squeeze spring loaded locking plates, then allow the leg to extend or retract. Optional replacement feet contains (2) rubber feet.



LADDER LEVELERS	LL600: \$125.95
REPLACEMENT ORANGE FEET	LL604: \$48.15
REPLACEMENT LOCKING CAPS & SCREWS	LL804-1: \$35.95

Chimney Bracket

Serves as a "starter" platform to level off sloped roof so 5' wide scaffold frames can be erected around chimney construction or chimney repairs. It is adjustable to most roof angles. Chimney Bracket includes: (2) brackets and (1) B74 brace. Can be used with Ultimate Ridge Hooks.

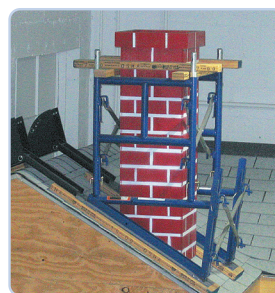

BRACKET
LLCB: \$784.47



Hoist Arm & Wheel

Hook the 12" diameter wheel onto the tubular framed hoist arm. The hook is equipped with a safety latch and entire assembly is zinc plated for rust protection. Use a maximum rope diameter of 1". We stock ropes with hook in 3/4" diameter x 60 ft or 100 ft length. (All sold separately.)



HOIST ARM	LLHA: \$132.39
HOIST ARM WHEEL	LLHAW: \$117.57
HOISTING ROPE W/HOOK 3/4" X100"	LLHR100: \$133.38
HOISTING ROPE W/HOOK 3/4" X60"	LLHR60: \$112.63

DrySafer Lint Alarm

Detect dangerous lint build up before it causes damage, potential injury, or death. When a dryer's airflow becomes restricted because of excessive lint build up, it can cause the dryer to overheat and possibly result in a fire. DrySafer Dryer Lint Alarm checks insufficient airflow inside the dryer's exhaust ducts and internal lint filter housing.



DRYSAFER SENSOR
DSL: \$34.95

Barger Clean Sweep Insert Puller

Insert Pullers are being used by chimney professionals across the country for their day-to-day operations. Removing a fireplace insert is strenuous work that may require more than one person. With a Clean Sweep Insert Puller, it's an easy one man job.

To use, simply adjust the puller to the height of the hearth extension using the adjustable legs. The legs will allow adjustment from the floor to 17" high. Once in place, slide the insert onto the rolling platform, and roll it back out of your way.

The Clean Sweep Insert Puller features solid construction with replaceable roller bearings that ensures it will last for many years. It's rated at an 800 lb. capacity, yet only weighs 27 lbs. The puller measures 18" wide, 49 1/2" long, 2 1/2" high, and the legs store within the frame. The Clean Sweep Insert Puller is easy to carry and stores easily in your service truck.

Specifications:

Overall Width: 18"

Overall Length: 49.5"

Legs: 16"

Weight: 27 lbs

Adjustment: From floor to 17" high

Capacity: 800 lbs

Rolling platform has full travel of the frame and is removable for bearing replacement. Legs are fully universal and store within the frame of the puller. Frame rails and rolling platform are angled at the end for sliding under insert.



SWEEP INSERT PULLER
BEIP: \$457.60

A. W. Perkins

Chimfex Fire Suppressant

Chimfex is indispensable as the first line of defense in controlling a fire in a chimney. An independent test lab reports that it suppresses a fire in an average of 22 SECONDS! It is an easy to use and effective means in controlling a chimney fire without water damage. Toss it alongside the fire, close the door and air intake vents, and the smoke emissions from Chimfex will rise up the flue to replace the oxygen. Use in a wood stove, fireplace or insert.



CHIMFLEX
AWP3412: \$21.91

Arbortech AS175 ALLSAW Masonry Restoration Kit



The new generation Allsaws functionality has been significantly enhanced. In accordance with OSHA regulations, the ALLSAW has been tested and proven to be significantly below the crystalline silica standard when operated with the Heavy Duty Dust Boot and a HEPA certified

vacuum. This package includes General Purpose Blades, Plunge Blades, Headjoint Blades, a Dust Boot, a Heavy Duty Dust Boot, an Key, Spare Blade Bolts (x4), and an Arbortech Carry Bag. With an improved motor and belt, this is an essential tool for trade applications. 13 Amp Tool has been highly enhanced for better performance with a more powerful motor and extended brush life, which enables a more seamless cutting experience. Heavy Duty Triple V Belt and a more efficient power transmission allows for a longer life and faster cuts. Vibration Reduction Handle further enhances ergonomics, allowing for extended use. Weight: 9.5lb

Order additional spare blades below:

AS175 ALLSAW	ARAS175: \$1,099.00
SWITCHBOX BLADES (2PK)	ARSBBLADE: \$94.99
GENERAL PURPOSE BLADE (2PK)	ARSGPBLADE: \$119.99
XL GENERAL PURPOSE BLADE (2PK)	ARSXLGP-BLADE: \$119.99
1/2" CAULKING BLADE	ARSCBLADE.5: \$119.99
1" CAULKING BLADE	ARSCBLADE1: \$119.99
2" CAULKING BLADE	ARSCBLADE2: \$119.99
PLUNGE BLADE (2PK)	ARSPBLADE: \$99.99
HEAD JOINT BLADE (2PK)	ARHJBLADE: \$84.99
HERITAGE BLADE (2PK)	ARSHBLADE: \$90.00

Safety & Protective Equipment

3M™ Half Face Respirator

- Made of silicone for greater comfort and helps provide a softer feel on the face.
- 3M™ Cool Flow™ Exhalation Valve allows easy exhalation for cool, dry comfort; and designed to be long lasting.
- Used with filters below to help protect against dust, gas and vapor.



**HALF FACE RESPIRATOR
3M7502: \$51.57**

3M™ Full Face Respirator



- Lightweight design with silicone face seal enhances comfort and improves durability.
- Wide field of vision
- Available in four different modes; can be used with both negative and powered and supplied-air systems
- Used with filters below to block 100% particulates (dust and soot), gas, and vapor.

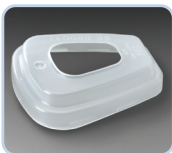

Both respirators use (1) package cartridge **3M6001**, (2) filters **3M5N11** and (2) retainers **3M501**.



FULL FACE RESPIRATOR	3M6900: \$256.47
RETAINER TO HOLD FILTER CARTRIDGE	3M501: \$3.78
FILTER PARTICULATE	3M5N11: \$2.87
ORGANIC VAPOR CARTRIDGE (2PK)	3M6001: \$23.53

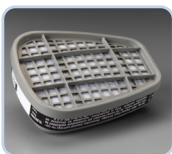

Head Sock

Keep your head and neck clean with this 7" knit head sock.

**12 PK HEAD SOCK
SGHS: \$28.00**



Soot Suit

These Tyvek Coveralls provide a durable, comfortable, impenetrable barrier against many hazardous particulates, including asbestos fibers and lead dust. Tear resistant and low linting with a full front zipper, attached hood, elastic wrists and ankles. XXL.



**SOOT SUIT
SUIT: \$15.21**

Coveralls

Kimberly-Clark KLEENGUARD™ Coveralls. Made of patented MICROFORCE™ barrier fabric, these coveralls have superior particle holdout while allowing excellent breathability. They offer high durability, have more chest room, longer body length and are antistatic. Zipper front, elastic back, wrists, ankles and hood, size XL.



**COVERALLS
KCA30: \$10.38**

Gloves & Booties

Protect your hands no matter what the task.

Price subject to change.

*Limited Availability



ATLAS (LARGE)	ATLASL: \$5.14
ATLAS (X-LARGE)	ATLASXL: \$4.77
COLD WEATHER WORK GLOVES	SG555: \$17.41
SWEEPS - BLACK 26" LENGTH	AWP275: \$32.09
VINYL (BOX OF 100)	SGT6336-L: \$10.14

Airjet Chimney Housing Kits



The following kits include:

- High Grade, Polished, Stainless Steel, Square Top Cap
- 4 Side Panels
- Simulated Red Brick
- Galvanized 2 piece Roof Flashing
- 18" Telescoping Aluminum Connector

These kits will fit the AirJet Gas Systems in 5", 6" or 7". Square Top Cap is UL approved for use with gas or oil. With only 8 parts the entire unit can be assembled on the ground and attached.

We stock red brick housing, other finishes are available. Please call for quote.

W X D X H

17" X 17" X 36"	SIMULATED RED BRICK	CIGHL36R: \$205.83
17" X 17" X 48"	SIMULATED RED BRICK	CIGHL48R: \$244.07

Rug Runner

Protect floors from extremely dirty traffic with this washable 4' by 12' natural color heavy canvas rug runner.

4'X12' RUNNER
SGRR: \$28.88



Tired of being put on hold or unable to place an order after hours?



National Chimney heard you and is now offering an e-commerce site for your convenience. Save money and time by placing your orders online 24 hours a day. No need to set up separate billing or shipping - all your account information remains the same. Call us today for your user name and password.



Save Time & Money with Our
E-STORE!

NationalChimneyStore.com 🔍

Scan the QR Code to Login!

SALES TOOLS



Inspection Reports

With these inspection reports you can record valuable information regarding your homeowner's appliances, stoves, fireplaces, and chimneys. It has three copies - one for your

(100/PKG)
\$39.00



Liner Sizing Charts

LINER SIZING CHARTS
WOOD BURNING

LSCWB:
\$4.20/EA.



National Chimney Brochures

M-FLEX Brochure (25/pk)

CBBROCHURE: \$9.19

Premier Cap Brochure (50/pk)

PTBROCHURE: \$5.25

Smoothwall Brochure (25/pkg)

SWBROCHURE: \$9.19

Refractory Panel Brochure (50/pk)

PFPBROCHURE: \$5.25

Chase Cover Brochure (50/pk)

CHASEBROCHURE: \$5.25

Multi Panel Brochure (25/pk)

MULTIBROCHURE: \$9.19

M-Flex Pre-Insulated Liner Brochure (50/pk)

MFPBROCHURE: \$5.25

Premier Mortar Preserve Brochure (100/pk)

PMPBROCHURE: \$12.60

Premier Stackable Single Flue Caps Brochure (50/pk)

PSFCBROCHURE: \$5.25

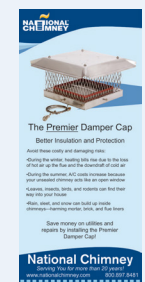
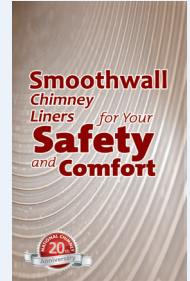
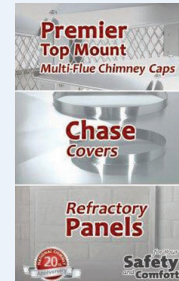
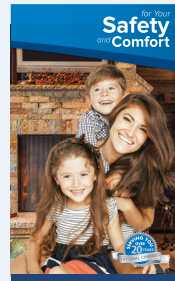

THANK YOU FOR YOUR BUSINESS!

WE WANT
TO HEAR
FROM YOU!



Take 5 minutes to complete our customer satisfaction survey! Your insights help us enhance our products, services, and overall shopping experience.



RECEIVE **\$50 OFF** YOUR NEXT E-STORE ORDER

- 1 Scan the QR code above to take the survey
- 2 Once you have finished, you will receive a confirmation email with your discount code.
- 3 Use the discount code at checkout on your next e-store order to receive \$50 off!

Ordering GUIDE



4 ORDERING OPTIONS FOR YOUR CONVENIENCE



ONLINE: www.NationalChimneyStore.com



EMAIL: Send to Order@NationalChimney.com



PHONE: **800-897-8481** (for custom orders & questions)



WALK-IN: Visit one of our locations!

Ways to Save on Shipping!

1. Free shipping via FedEx or LTL on qualifying orders of \$1100 or more. Anywhere in the U.S.
2. Free shipping via our delivery trucks on orders \$400 or more

Custom products, Refractory panels and Premier Mix Insulation do not qualify for free shipping. All accessorial fees are not covered by the free shipping policy. i.e. Residential delivery, lift gate, and extreme length fees.



Free Delivery Schedule for Qualifying Customers

MIDWEST FACILITY

- Tuesdays
- Thursdays

MID-ATLANTIC FACILITY

- Mondays
- Tuesdays
- Wednesdays
- Thursdays

NORTHEAST FACILITY

- Tuesdays
- Wednesdays
- Thursdays

Delivery Date Estimator

Need Product On	Order by 5 PM on the Preceding
Monday	Thursday
Tuesday	Friday
Wednesday	Monday
Thursday	Tuesday

Terms & Conditions

PAYMENT TERMS

For your initial order, you must pay using a Money Order, a Certified Check, or a Credit Card.

New customers will receive a Welcome Packet containing a credit application. We ask that you complete it fully, and mail it back to the address on the credit application. Your credit application will be processed as soon as it's received, and you will be notified by mail of your approved credit status.

We accept Cash, Money Orders, Debit Cards, and Credit Cards (Visa, Mastercard, Discover, American Express). We will also accept Checks and Check By Fax; however, any returned checks will be assessed a \$50 service charge.

All past due accounts are subject to an interest charge of 1.5% per month (18% interest annually). We reserve the right to place any account that is past due on credit hold, COD, and/or Certified Funds Only—without prior notification—until the account is made current.

SHIPPING

Orders can ship via FedEx, FedEx Ground, Common Carrier / LTL, and National Chimney's Delivery Truck. Some orders must ship by common carrier; we reserve the right to ship your order via freight, if necessary.

RETURNS

All product must be returned in "like-new" condition, in the original packaging—unless it was damaged upon arrival. If the packaging is damaged, please do not accept the shipment. If only part of the order is damaged, please note precisely the damage on the bill of lading for the carrier. Call your Customer Service Representative to explain the reason for the declined/unaccepted item(s). We will provide you with an RMA number and determine how and where the items will be returned.

Item(s) returned may be subject to a restocking fee. Special orders and custom items are non-refundable and non-returnable—unless damaged during shipping.

CREDITS

All products will be inspected upon receipt. At that time, we will decide whether a credit is due or a restocking charge is applicable. We reserve the right to accept or deny the product, according to its re-sale value.

Items in less than sales worthy condition, unless previously discussed (such as damaged items), will not be credited.

Returned items which can be re-sold will be credited to your account. A copy of the credit memo invoice will be mailed to you. If the returned items were paid for with a credit card, credit will be issued to that card. If you paid COD, a refund check will be mailed to you with a copy of your credit memo invoice. If you currently have net terms, your account will be credited and that amount can be deducted from your next payment.

QUESTIONS ABOUT YOUR PAYMENT TERMS, BILLING, RETURNS AND/OR CREDIT?

Please Contact Accounting:

TOLL FREE: 877.338.1213

FAX: 802.383.0056



Chase Cover Specification Pricing Worksheet

Effective as of
5/1/2026

Company: _____ PO: _____

DATE: _____

Customer Name: _____

Order # _____

No Hole Single Hole Centered

MATERIAL:

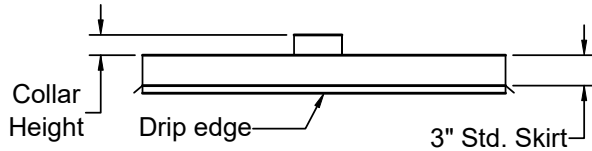
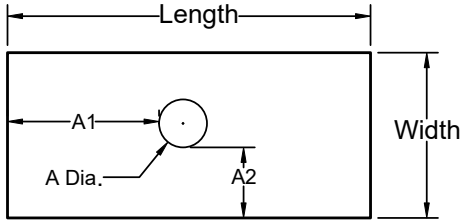

- 24 Ga. Stainless Multiplier : (\$ 3.39)
- 16 Oz. Copper Multiplier : Call for Pricing
- Aluminum Multiplier : (\$ 3.07)

**** All dimensions to include clearances for chasecover and holes**

Width: _____ Length: _____ Skirt : _____

A1: _____ A 2: _____ A Dia : _____

Collar Height: _____ Std. Collar EZ Collar

** Standard Silicone Sealed Collars

Drip Edge: Yes / No Crossbreak: Yes / No

PRICING MULTIPLIER EXAMPLE

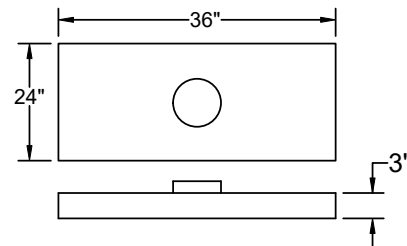

$$42'' \frac{(\text{Length} + 2\text{Skirt})}{(36 + 3 + 3)} + 30'' \frac{(\text{Width} + 2\text{Skirt})}{(24 + 3 + 3)}$$

SOLUTION = 42 + 30 x Multiplier = \$ _____

Price: \$ _____

For chase covers larger than 42" wide and 96" long, call for additional pricing

For multiple holes add \$20 each
For EZ collars add \$35 Each

** Options:

- * 3 or more holes.
- * Oval, square / Rectangular Holes. Add \$20 per Hole
- * Heavier Gauge Steel
- * Angle supports inside larger sized chase covers

POWDER COAT: YES NO

(Call for pricing)

Standard Colors

Flat Black, Satin Black, Bright white, Off White, Green, Brown, Brick Red, New Copper, Antique Copper, Bronze

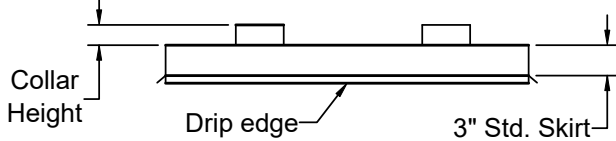
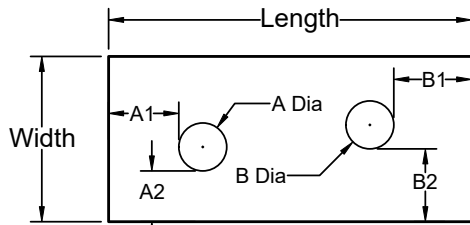

Width: _____ Length: _____ Skirt : _____

A1: _____ A 2: _____ A Dia: _____

B1: _____ B2: _____ B Dia: _____

**** All dimensions to include clearances for chasecover and holes**

A Collar Height: _____ B Collar Height: _____

Std. Collar EZ Collar

** Standard Silicone Sealed Collars

Drip Edge: Yes / No Crossbreak: Yes / No



Phone: 800-897-8481

Fax: 800-628-9938

www.nationalchimney.com

TOP MOUNT MULTI-FLUE CHIMNEY CAP

Company: _____ PO: _____ DATE: _____

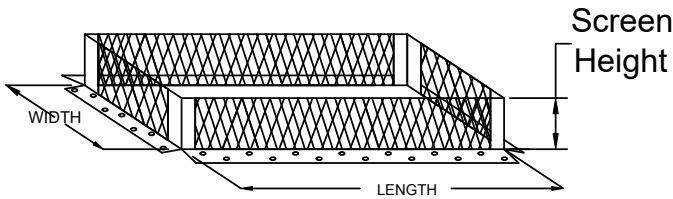

ORDER # _____

STANDARD SCREEN HEIGHTS

Stainless: 8" 10" 12" 16"

Copper: 8" 10" 12"

Other: _____ (ADD 5% TO HEIGHTS 17-24)
(HEIGHTS BEYOND 24" CALL FOR PRICE)

Flat Pricing

(Length + Width + Height) x Multiplier = Cost

FOR TOTAL LENGTH + WIDTH + HEIGHT

- Stainless Multiplier:
0 - 60" = 3.71
61" - 70" = 3.98
71" - 100" = 4.24
101"+ = Call for Pricing
- Copper: Call for Pricing

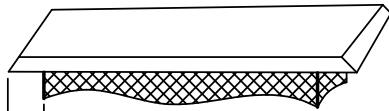

3" Standard Overhang

* NO FRACTIONAL DIMENSIONS ON TOP MOUNT CAPS

SIZING REQUIREMENTS

Length: _____ "

Width: _____ "

Overhang: _____ "

(ADD 10% FOR ADDITIONAL OVERHANG UP TO 6")

Hip & Ridge

(Length + Width) x Multiplier = Cost

FOR CAP SIZES UP TO 45" WIDE AND 67" IN LENGTH

- Stainless: Multiplier = (8.46)
 Copper: Call for Pricing

FOR CAP SIZES 46"- 65" WIDE OR LENGTHS 68"-100"

- Stainless: Multiplier = (10.58)
 Copper: Call for Pricing

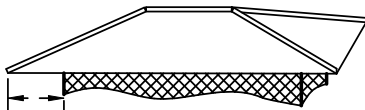

4" Standard Overhang

Lid Pitch: ____/12 (Std. 5/12)
(ADD 10% FOR LID PITCH 6/12 TO 12/12)

CAP TOTAL \$ _____

POWDERCOAT TOTAL \$ _____

TOTAL COST OF CAP \$ _____

Hip

(Length + Width) x Multiplier = Cost

FOR CAP SIZES UP TO 45" WIDE AND 67" IN LENGTH

- Stainless: Multiplier = (9.20)
 Copper: Call for Pricing

FOR CAP SIZES 46"- 65" WIDE OR LENGTHS 68"-100"

- Stainless: Multiplier = (11.50)
 Copper: Call for Pricing

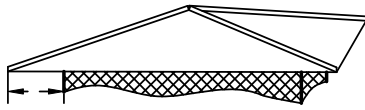

4" Standard Overhang

Lid Pitch: ____/12 (Std. 5/12)
(ADD 10% FOR LID PITCH 6/12 TO 12/12)

POWDER COAT

- | | |
|---|---|
| <input type="checkbox"/> FLAT BLACK | <input type="checkbox"/> SATIN BLACK |
| <input type="checkbox"/> PURE WHITE | <input type="checkbox"/> TRAFFIC WHITE |
| <input type="checkbox"/> BLACK / GREEN | <input type="checkbox"/> BROWN |
| <input type="checkbox"/> BRICK RED | <input type="checkbox"/> COPPER |
| <input type="checkbox"/> STATUTORY BRONZE | <input type="checkbox"/> ANTIQUE COPPER |
| <input type="checkbox"/> CUSTOM | |

COLOR _____

CUSTOM COLORS WILL HAVE AN ADDITIONAL COST

Standing Seam

(Length + Width) x Multiplier = Cost

FOR CAP SIZES UP TO 45" WIDE AND 67" IN LENGTH

- Stainless: Multiplier = (9.22)
 Copper: Call for Pricing

FOR CAP SIZES 46"- 65" WIDE OR LENGTHS 68"-100"

- Stainless: Multiplier = (11.53)
 Copper: Call for Pricing

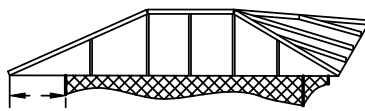

4" Standard Overhang

Lid Pitch: ____/12 (Std. 5/12)
(ADD 10% FOR LID PITCH 6/12 TO 12/12)

PITCHED SKIRT STYLE MULTI-FLUE CHIMNEY CAP

Company: _____ PO: _____ Date: _____

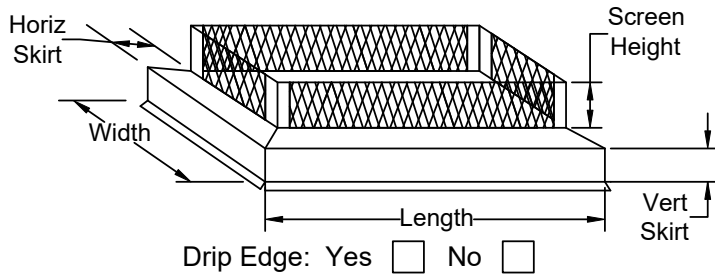

ORDER # _____

STANDARD SCREEN HEIGHTS

Stainless: 8" 10" 12" 16"

Copper: 8" 10" 12"

Other: _____ (ADD 5% TO HEIGHTS 17-24)
(HEIGHTS BEYOND 24" CALL FOR PRICE)

PRICING MULTIPLIER = Length + Width x Multiplier = Cost

Flat

FOR CAP SIZES UP TO 33" WIDE AND 67" IN LENGTH

Stainless: Multiplier = (8.10)

Copper: Call for Pricing

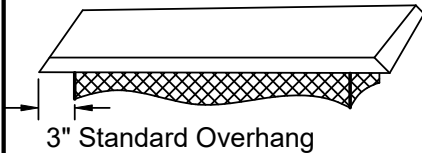

FOR CAP SIZES 34" - 49" WIDE OR LENGTHS 68" - 100"

Stainless: Multiplier = (10.12)

Copper: Call for Pricing

SIZING REQUIREMENTS

Length: _____ "

Width: _____ "

Vertical Skirt: _____ " (Std. 3")
(Skirts 5-8" add 5%)

Horizontal Skirt: _____ " (Std. 2")

Overhang: _____ "
(Add 10% for Extra Overhang upto 6")

Hip & Ridge

FOR CAP SIZES UP TO 45" WIDE AND 67" IN LENGTH

Stainless: Multiplier = (9.96)

Copper: Call for Pricing

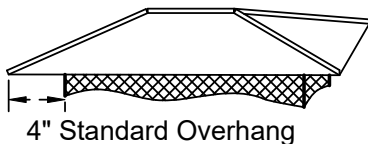

FOR CAP SIZES 46" - 65" WIDE OR LENGTHS 68" - 100"

Stainless: Multiplier = (12.46)

Copper: Call for Pricing

Lid Pitch: ____/12 (Std. 5/12)
(ADD 10% FOR LID PITCH 6/12 TO 12/12)

CAP TOTAL \$ _____

POWDERCOAT COST \$ _____

TOTAL COST OF CAP \$ _____

Hip

FOR CAP SIZES UP TO 45" WIDE AND 67" IN LENGTH

Stainless: Multiplier = (10.67)

Copper: Call for Pricing

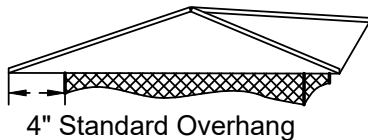

FOR CAP SIZES 46" - 65" WIDE OR LENGTHS 68" - 100"

Stainless: Multiplier = (13.34)

Copper: Call for Pricing

Lid Pitch: ____/12 (Std. 5/12)
(ADD 10% FOR LID PITCH 6/12 TO 12/12)

POWDER COAT

- FLAT BLACK
- SATIN BLACK
- PURE WHITE
- TRAFFIC WHITE
- BLACK / GREEN
- BROWN
- BRICK RED
- COPPER
- STATUTORY BRONZE
- ANTIQUE COPPER
- CUSTOM

COLOR _____

CUSTOM COLORS WILL HAVE
AN ADDITIONAL COST

Standing Seam

FOR CAP SIZES UP TO 45" WIDE AND 67" IN LENGTH

Stainless: Multiplier = (13.25)

Copper: Call for Pricing



FOR CAP SIZES 46" - 65" WIDE OR LENGTHS 68" - 100"

Stainless: Multiplier = (16.56)

Copper: Call for Pricing

Lid Pitch: ____/12 (Std. 5/12)
(ADD 10% FOR LID PITCH 6/12 TO 12/12)

SKIRT STYLE MULTI-FLUE CHIMNEY CAP

Company: _____ PO: _____ Date: _____

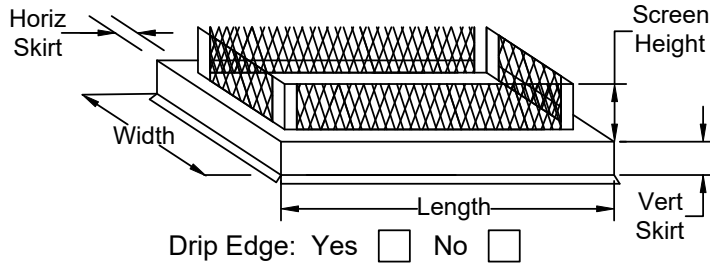

ORDER # _____

STANDARD SCREEN HEIGHTS

Stainless: 8" 10" 12" 16"

Copper: 8" 10" 12"

Other: _____ (ADD 5% TO HEIGHTS 17-24)
(HEIGHTS BEYOND 24" CALL FOR PRICE)

PRICING MULTIPLIER = Length + Width x Multiplier = Cost

Flat

FOR CAP SIZES UP TO 33" WIDE AND 67" IN LENGTH

- Stainless: Multiplier = (6.86)
- Copper: Call for Pricing

FOR CAP SIZES 34" - 49" WIDE OR LENGTHS 68"-100"

- Stainless: Multiplier = (8.58)
- Copper: Call for Pricing

SIZING REQUIREMENTS

Length: _____ "

Width: _____ "

Vertical Skirt: _____ " (Std. 3")
(Skirts 5-8" add 5%)

Horizontal Skirt: _____ " (Std. 2")

Overhang: _____ "
(Add 10% for Extra Overhang upto 6")

CAP TOTAL \$ _____

POWDERCOAT COST \$ _____

TOTAL COST OF CAP \$ _____

POWDER COAT

- FLAT BLACK
 - SATIN BLACK
 - PURE WHITE
 - TRAFFIC WHITE
 - BLACK / GREEN
 - BROWN
 - BRICK RED
 - COPPER
 - STATUTORY BRONZE
 - ANTIQUE COPPER
 - CUSTOM
- COLOR _____

CUSTOM COLORS WILL HAVE AN ADDITIONAL COST

Hip & Ridge

FOR CAP SIZES UP TO 45" WIDE AND 67" IN LENGTH

- Stainless: Multiplier = (9.57)
- Copper: Call for Pricing

FOR CAP SIZES 46" - 65" WIDE OR LENGTHS 68"-100"

- Stainless: Multiplier = (11.96)
- Copper: Call for Pricing

Hip

FOR CAP SIZES UP TO 45" WIDE AND 67" IN LENGTH

- Stainless: Multiplier = (9.95)
- Copper: Call for Pricing

FOR CAP SIZES 46" - 65" WIDE OR LENGTHS 68"-100"

- Stainless: Multiplier = (12.44)
- Copper: Call for Pricing

Standing Seam

FOR CAP SIZES UP TO 45" WIDE AND 67" IN LENGTH

- Stainless: Multiplier = (12.90)
- Copper: Call for Pricing

FOR CAP SIZES 46" - 65" WIDE OR LENGTHS 68"-100"

- Stainless: Multiplier = (16.13)
- Copper: Call for Pricing

WHERE TO FIND US THIS YEAR



JANUARY

Lindeman University
NEHPBA Board Meeting
PA Chimney Sweep Guild
MCSG Winter Banquet & Annual Meeting

FEBRUARY

North Carolina Winter Meeting
NCSG Show
MACA Board Meeting



MARCH

HPBA Expo Affiliate Receptions
Sweeps Week

APRIL

MACA Masonry Workshop

MAY

Mid-Atlantic HPBA Annual Conference
NEHPBA
PA Guild Workshop
Wisconsin Guild Summer Workshop



JUNE

Sweepfest
North Central HPBA

JULY

Golden State Guild
NY Guild Summer Workshop



AUGUST

Chimney Expo

SEPTEMBER

South Carolina Gathering

GIVING BACK TO OUR COMMUNITY

Sweep Away Cancer

At National Chimney, we are deeply committed to giving back to our community, which is why we are proud to be founders and the largest contributors to Sweep Away Cancer.

Run by a board of chimney professionals, this non-profit organization raises money and awareness for individuals affected by cancer, many of whom are part of the chimney industry, veterans, and first responders. We invite you to join us in this meaningful cause and make a difference in the lives of those battling cancer. Together, we can Sweep Away Cancer and bring hope to those who need it most.



Join us in May for the Sweep Away Cancer Rally in Vienna, VA!

GET INVOLVED

- Buy apparel for your team members or customers.
- Ask your customers if they would like to donate.
- Donate a percentage of your company's proceeds from the month of October.
- Attend a Sweep Away Cancer event.

To learn more, visit www.sweepawaycancer.com

Warrior Horse

We also donate a percentage of our profits to Warrior Horse.

Warrior Horse offers a transformative equine therapy program called the "Bonding Process" for U.S. military veterans diagnosed with PTSD. This personalized, interactive approach is provided free of charge to veterans, aiming to kickstart their recovery after active duty.



To learn more, visit www.warriorhorse.net

"They protected our way of life. It's time that we help them get their lives back."





CORPORATE HEADQUARTERS

2147C Fletcher Avenue
Indianapolis, IN 46203

NORTHEAST

3 Green Tree Drive
South Burlington, VT 05403

MID-ATLANTIC

2601 Emory Road
Finksburg, MD 21048

HOW TO REACH US

800.897.8481

